

brother

Operation Manual

Cutting Machine

Product Code: 891-Z05

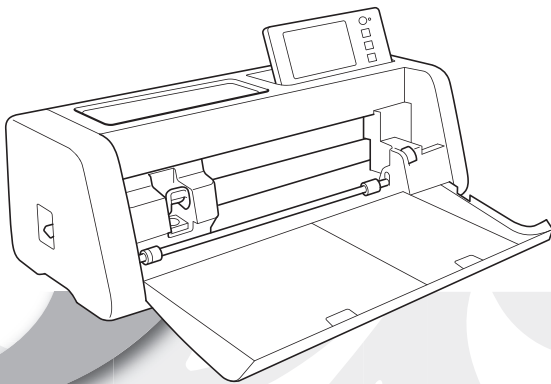

Be sure to read this document before using the machine.

Terms of Use

IMPORTANT-PLEASE READ CAREFULLY:

This Terms of Use ("Agreement") is a legal agreement between Brother Industries, Ltd. ("Company") and you that governs your use of any Software, installed on or made available by Company for use with sewing or craft products ("Company Product"). The term of "Software" means any and all contents data, design data, data format, firmware of Company Product, and PC application or mobile device application.

By using the Software and Company Product, you shall be deemed to have agreed to be bound by the terms of this Agreement. If you do not agree to the terms of this Agreement, Company is unwilling to license the Software and you are not allowed to use the Software. Amendments and supplements to this Agreement may be attached to the Software.

An individual who accepts this Agreement on behalf of an entity represents to Company that he or she has the legal right to enter into a binding legal agreement for that entity.

Terms and Conditions

1 Grant of License.

- 1.1 Subject to this Agreement, Company hereby grants you a personal, non-exclusive, non-transferable and revocable license to use the Software only within the Company Product.
- 1.2 Your right to use of the Software is licensed and not sold, and solely for your use subject to this Agreement. Company or its suppliers retains all right, title, and interest relating to Software, including without limitation all intellectual property rights relating thereto.

2 Restrictions

- 2.1 Except as expressly set out in this Agreement or as required by any local law, you shall undertake:
 - 2.1.1 not to disassemble, de-compile, reverse engineer, translate or otherwise attempt to learn the source code of the Software(including the data or contents created by using the Company Product or contents editing application software; hereinafter the same shall apply in this Clause 2.);
 - 2.1.2 not to create derivative works based on the whole or any part of the Software;
 - 2.1.3 not to distribute, provide or make available the Software in any form, in whole or in part to any person without prior written consent from Company;
 - 2.1.4 not to copy the Software, except where such copying is incidental to normal use of the Software with Company Product or where it is necessary for the purpose of back-up or operational security;
 - 2.1.5 not to transfer, rent, lease, sub-license, loan, translate, merge, adapt, vary, alter or modify, the whole or any part of the Software nor permit the Software or any part of it to be combined with, or become incorporated in, any other programs;
 - 2.1.6 to include Company's copyright notice and this Agreement on all entire and partial copies of the Software; and
 - 2.1.7 not to use the Software for any purpose (including, but not limited to, use with unauthorized sewing/craft products or software) other than as provided under Clause 1 of this Agreement.

3 No warranty

TO THE EXTENT PERMISSIBLE BY APPLICABLE LAW, THIS SOFTWARE IS PROVIDED TO YOU "AS IS" WITHOUT WARRANTIES OR CONDITIONS OF ANY KIND, WHETHER ORAL OR WRITTEN, EXPRESS OR IMPLIED. COMPANY SPECIFICALLY DISCLAIMS ANY IMPLIED WARRANTIES OR CONDITIONS OF MERCHANTABILITY, SATISFACTORY QUALITY, NON-INFRINGEMENT AND/OR FITNESS FOR A PARTICULAR PURPOSE.

4 Limitation of liability

- 4.1 COMPANY SHALL NOT BE LIABLE TO YOU, ITS END-USERS OR ANY OTHER ENTITY FOR ANY LOSS OF PROFITS OR INCOME OR SAVINGS, LOSS OF DATA, INTERRUPTION OF USE, OR CONSEQUENTIAL, INCIDENTAL, SPECIAL, PUNITIVE OR INDIRECT DAMAGES INCURRED BY SUCH PARTY (WHETHER IN AN ACTION IN CONTRACT OR TORT), EVEN IF COMPANY HAS BEEN ADVISED OF THE POSSIBILITY OF SUCH DAMAGES, ARISING OUT OF OR RELATING TO THE SOFTWARE, SUPPORT SERVICE OR THIS AGREEMENT. THESE

LIMITATIONS SHALL APPLY TO THE MAXIMUM EXTENT ALLOWED BY APPLICABLE LAW NOTWITHSTANDING ANY FAILURE OF ESSENTIAL PURPOSE OF ANY LIMITED REMEDY.

- 4.2 NOTWITHSTANDING THE CLAUSE 3 OR 4.1 HEREOF, THIS AGREEMENT DOES NOT PURPORT TO EXCLUDE OR RESTRICT COMPANY'S LIABILITY FOR DEATH OR PERSONAL INJURY RESULTING FROM NEGLIGENCE OR LIMIT THE STATUTORY RIGHTS OF A CONSUMER.

5 Termination

- 5.1 Company shall have the right to terminate this Agreement at any time by providing a written notice to you if you commit a material breach of any terms of this Agreement and fail to immediately rectify such breach upon Company's request.
- 5.2 Upon termination for any reason all rights granted to you under this Agreement shall cease, you shall cease all activities authorized by this Agreement and you shall immediately delete or remove the Software from all computer equipment in your possession and delete or destroy all copies of the Software or its derivative works in your possession. In addition to the above, you shall delete contents or design data created by you from the Company Product in your possession.

6 Miscellaneous terms

- 6.1 You shall not export or re-export the Software or any copy or adaptation thereof in violation of any applicable laws or regulations.
- 6.2 You shall not assign all or any part of this Agreement to any third party or any interest therein, without prior written consent of Company. A change of control or reorganization of you pursuant to a merger, sale of assets or stock shall be deemed to be an assignment under this Agreement.
- 6.3 You agree that a breach of this Agreement will cause irreparable injury to Company for which monetary damages would not be an adequate remedy and Company shall be entitled to seek equitable relief in addition to any remedies it may have hereunder or at law without a bond, other security, or proof of damages.
- 6.4 If any provisions of this Agreement shall be declared or determined as void or unenforceable by a court of competent jurisdiction, such provisions shall be severable and independent from the other provisions of this Agreement and the validity of the other provisions and of the entire Agreement shall not be affected thereby.
- 6.5 This Agreement, together with all exhibits or other attachments referenced herein, constitutes the entire agreement between the parties on the subject matter hereof, and supersedes all proposals, oral and written, between the parties on this subject.
- 6.6 If Company fails to insist that you perform any of your obligations under this Agreement, or if Company does not enforce any rights against you, or if Company delay in doing so, that will not mean that Company have waived any rights against you and will not mean that you do not have to comply with those obligations. If Company does waive a default by you, Company will only do so in writing, and that will not mean that Company will automatically waive any later default by you.
- 6.7 The laws of the state or country where you live (or, if a business, where your principal place of business is located) govern all claims and disputes concerning the Software or this Agreement.

INTRODUCTION

Thank you for purchasing this machine.

Before using this machine or attempting any maintenance, carefully read the "IMPORTANT SAFETY INSTRUCTIONS" on the Product Safety Guide, and then read the Operation Manual for the correct operation of the various functions. In addition, after you have finished reading this manual, store it where it can quickly be accessed for future reference. Failure to follow these instructions may result in an increased risk of personal injury or damage to property, including through fire, electrical shock, burns or suffocation.



IMPORTANT NOTICE

- This machine is intended for household use.
- This machine is approved for use in the country of purchase only.
- Due to product quality improvements, the specifications or appearance of this machine may change without notice.
- The screens in this manual are for illustration purposes only and may differ from the actual screens.
- The contents of this document are subject to change without notice.
- The contents of this document may not be duplicated or reproduced, partially or in full, without permission.
- We assume no responsibility for damages arising from earthquakes, fire, other disasters, actions of third parties, the user's intentional or negligent operation, misuse or operation under other special conditions.
- For additional product information, visit our web site at www.brother.com

IMPORTANT SAFETY INSTRUCTIONS

Symbols Used in This Document

The following symbols are used in this document.

 WARNING	Failure to observe instructions with this marking may result in fatal or critical injuries.
 CAUTION	Failure to observe instructions with this marking may result in serious injuries.

CONTENTS

Terms of Use	i
INTRODUCTION	1
IMPORTANT NOTICE	1
IMPORTANT SAFETY INSTRUCTIONS	1
Symbols Used in This Document	1
FEATURES.....	4
Patterns (“Pattern” mode)	4
Scanning (“Scan” mode)	4
Transferring Data using the Wireless Network Connection Function	5

1 GETTING STARTED.....6

PARTS AND FUNCTIONS	6
Unit Descriptions - Front	6
Unit Descriptions - Rear	7
Unit Descriptions - Operation Panel	7
Included Accessories	7
BEFORE USE	8
Removing the Packing Materials.....	8
Turning On/Off the Machine.....	8
Preparing for Feeding the Mat	9
Operation of LCD Panel	9
MACHINE SETTINGS	10
Settings Screen	10
Auto Shutdown.....	12

2 BASIC OPERATIONS.....13

FIRST STEPS.....	13
Selecting the Mat Appropriate for the Material	13
Reference Table of Mat and Material Combinations	14
Attaching the material to the mat.....	16
Blade and Material Combination.....	23
Installing and Uninstalling the Holder.....	24
Test Cut (Trial Cut)	25
PATTERN CUTTING	29
Tutorial 1 - Cutting Patterns.....	29
Tutorial 2 - Cutting Advanced Patterns.....	32
PATTERN SELECTION	38
Selecting a Single Pattern	38
Selecting Multiple Patterns	38

3 ADVANCED OPERATIONS...40

CUTTING AND EDITING FUNCTIONS.....	40
Pattern Editing Functions.....	40
Pattern Editing Functions - Multiple Patterns	41
Mat Layout Screen	41
Layout Editing Functions.....	42
Object Editing Screen	43
Undoing an Operation.....	44
Grouping/Ungrouping Patterns.....	44
Welding (Merging the Outlines of Multiple Patterns)	46
Aligning Patterns	47

Auto Layout Functions	49
Scanning a Background Image.....	50
Character Input Functions.....	51

MEMORY FUNCTIONS

Saving	53
Retrieve Data.....	54
Retrieve from CanvasWorkspace (Via a Wireless Network Connection)	55
Retrieve from CanvasWorkspace (Using a USB Cable) (compatible only with Windows)	56
Importing Designs	57

Retrieving Embroidery Data for Cutting (Compatible Models Only).....

Preparing .phc or .pes Files	58
Retrieving the Pattern to the Cutting Machine.....	58
Creating Appliqué Data	59
Creating Embroidering Line Data.....	59

DRAWING FUNCTIONS

Drawing	62
Cutting Around Drawings.....	63
Using Drawing Functions to Fill Patterns/Make Outlines Thicker	67

4 SCANNING FUNCTIONS...69

SCANNING FOR CUTTING (Direct Cut).....

Tutorial 3 - Scanning and Cutting	69
Advanced Cutting Functions for “Direct Cut”	73

CREATING CUTTING DATA (Scan to Cut

Data).....

Tutorial 4 - Creating Cutting Data	75
Adjusting Image Detection Levels.....	81

SCANNING IMAGES (Scan to USB).....

Notes on Scanning.....	83
Tutorial 5 - Scanning to USB	83
Selecting the Area to be Saved.....	85
Transferring an Image to CanvasWorkspace	85

5 APPENDIX87

CONSUMABLES.....

Replacement Criteria.....	87
Replacing the Blade	87

CARE AND MAINTENANCE

Cleaning	89
Cleaning the Scanner Glass.....	91
Adjusting the Screen	92
Adjusting the Scanning/Cutting Position	92
Adjusting the Position of the Feed Roller.....	94

TROUBLESHOOTING

ERROR MESSAGES.....

UPDATING THE SOFTWARE.....

Automatic Update Function	102
Update Procedure Using USB Flash Drive	103
Update Procedure Using the Application (CanvasWorkspace)	103

OPTIONAL ACCESSORIES.....

PRODUCT SPECIFICATIONS	105
INDEX	106

FEATURES

Patterns (“Pattern” mode)

Select a pattern and edit it to create your own design. By simply loading craft paper or fabric, you can quickly create precision paper and fabric cutouts.



The editing functions of ScanNCut DX will allow you to easily edit the built-in patterns to create your own design.

Scanning (“Scan” mode)

Scan an illustration, photo or your own drawing to create personalized cut designs. The design can then be cut out or saved as data.



Without your PC or mobile device, you can scan your choice of pattern, use/edit the scanned design, and save the pattern for later use.

Home screen

Select a pattern.
 “Tutorial 1 - Cutting Patterns” on page 29
 “Tutorial 2 - Cutting Advanced Patterns” on page 32

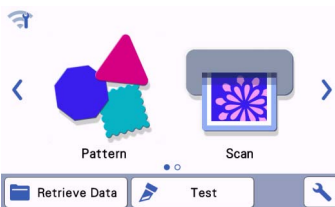

Scan an image.
 “Tutorial 3 - Scanning and Cutting” on page 69
 “Tutorial 4 - Creating Cutting Data” on page 75
 “Tutorial 5 - Scanning to USB” on page 83

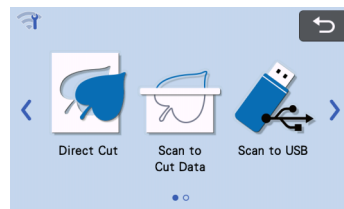

Transferring Data using the Wireless Network Connection Function

This machine is equipped with a wireless network connection function. With this function, patterns edited in the dedicated application CanvasWorkspace can be transferred to the machine via a wireless network connection. Refer to the following to use the wireless network connection function.

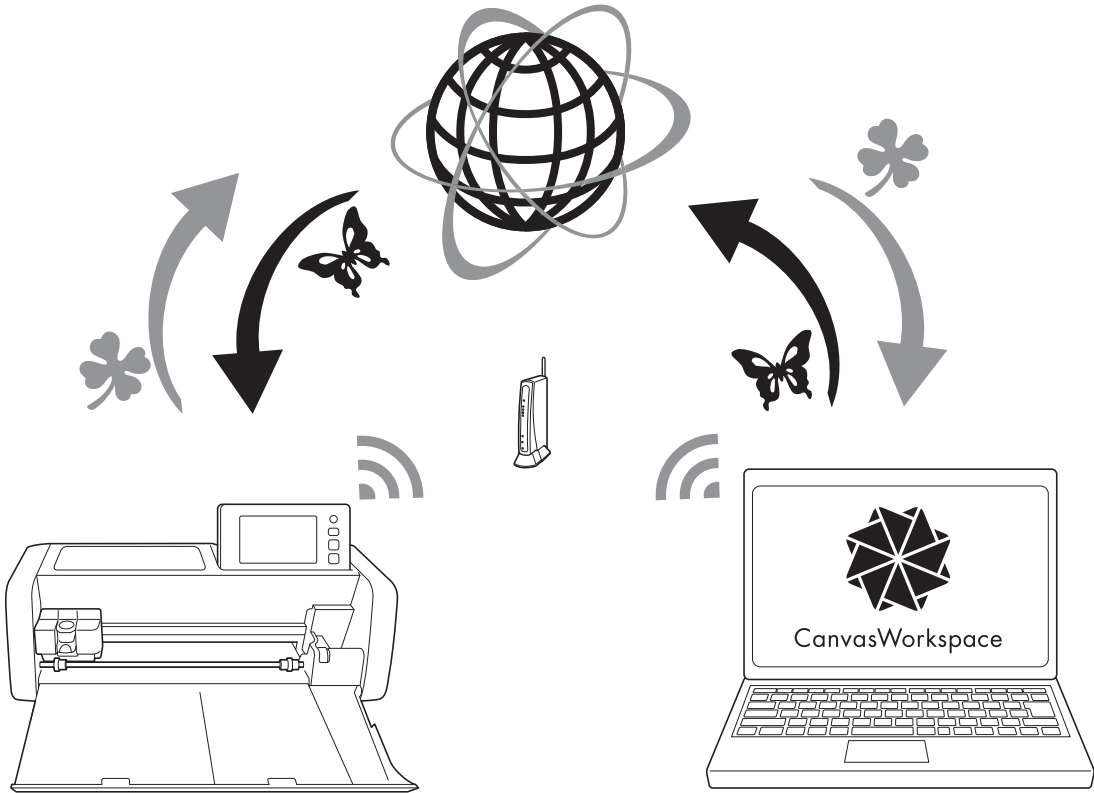

1. Connecting to a wireless network:

Touch  in the home screen to specify the wireless network connection settings. For the connection procedure, refer to “Wireless Network Setup Guide”.

2. Login to CanvasWorkspace Internet version.

In order to use CanvasWorkspace, a CanvasWorkspace (formerly ScanNCutCanvas) login ID is necessary. If you do not have a free account, go to <<http://CanvasWorkspace.Brother.com>> to create a new account.

3. Register machine under CanvasWorkspace.

In order to save or retrieve patterns, your machine must first be registered with CanvasWorkspace. For details, refer to “Wireless Network Setup Guide”.

4. Retrieving/saving patterns:

Patterns can be downloaded or uploaded, without using a USB flash drive. For details, see “Saving” on page 53 and “Retrieve Data” on page 54.

CanvasWorkspace (PC Version) is a PC based application that allows you to create and edit cutting or drawing pattern data to download to your cutting machine. The PC version allows you to edit the pattern data without an Internet connection.

You can download this application from the following URL:

<http://s.brother/cuoad/>

The CanvasWorkspace Internet version provides you access to a variety of projects with step by step instructions.

Chapter 1 GETTING STARTED

PARTS AND FUNCTIONS

Unit Descriptions - Front

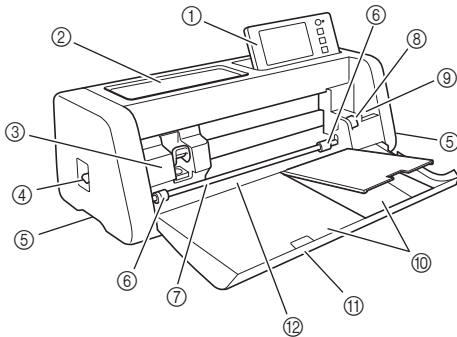

- ① **Operation Panel**
Allows you to control the unit and specify settings with the LCD panel and operating buttons. The angle of the operation panel can be adjusted.
- ② **Tool Tray**
Stores accessories for easy access during use.
- ③ **Carriage**
Moves the installed holder for cutting or drawing.

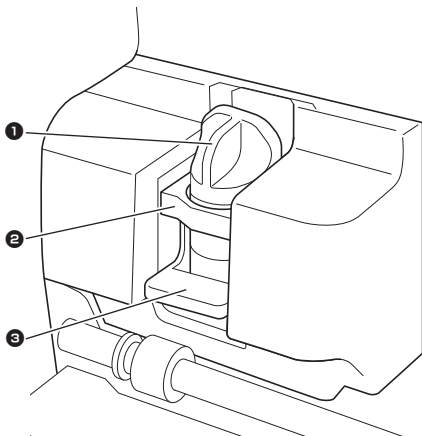

- ① **Holder**
Installs in the carriage to cut or draw on craft paper or fabric. Use the holder designed specifically for cutting or drawing.
- ② **Holder Guide**
The guide secures the holder.
- ③ **Holder Lock Lever**
Releases the holder when the lever is raised. Locks the holder when the lever is lowered.

- ④ **Scanner Lever**
Adjusted according to the operation being performed. For details, see “Preparing for Feeding the Mat” on page 9.
- ⑤ **Grips**
Grasped when moving the machine.
- ⑥ **Feed Rollers**
Should be adjusted on the right side when the optional roll feeder is used. For details, see “Adjusting the Position of the Feed Roller” on page 94.
- ⑦ **Shaft**
Drives a feed roller on each end to feed the mat.
- ⑧ **Feeder Release Lever**
Locks or releases the shaft when the optional roll feeder is used. For normal operations, set to the locked position. For details, see “Adjusting the Position of the Feed Roller” on page 94.
- ⑨ **Tool Holder**
Holds accessories upright for easy access during use.
- ⑩ **Storage**
Stores accessories.
- ⑪ **Front Tray Cover**
Protects the feed rollers, carriage and holder. Open the cover while the machine is operating.
- ⑫ **Feed Slot**
Feeds in the mat when it is loaded.

Unit Descriptions - Rear

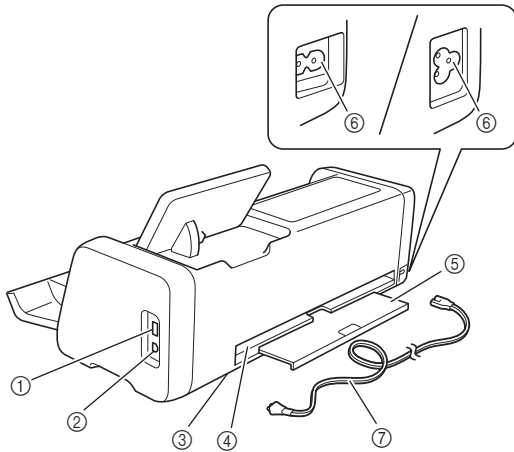

- ① **USB Port (for a USB flash drive)**
Allows a USB flash drive to be connected for saving and recalling data.
- ② **USB Port (for a computer)**
Allows a USB cable to be connected for saving and recalling data. For Computers and Operating Systems, see “Connecting Your Machine to the Computer” on page 56.
- ③ **Scanner Glass (inside of machine)**
Can be maintained after the rear tray has been removed. For details, see “Cleaning the Scanner Glass” on page 91.
- ④ **Slot**
Allows a mat to be fed back and forth during an operation. Do not place any objects near the slot that would prevent the mat from being fed out.
- ⑤ **Rear Tray**
Supports the mat when it is fed out of the slot during operation. Be sure to pull out this tray before using the machine.
- ⑥ **AC Power Jack**
- ⑦ **AC Power Cord**

Unit Descriptions - Operation Panel

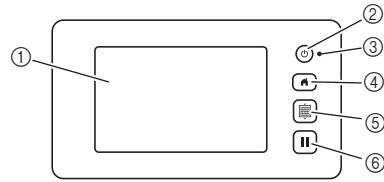

- ① **LCD Panel**
Displays operation screens, preview images of patterns and error messages.
- ② **Power Button**
Turns the machine on/off.
- ③ **Power Indicator**
Lights up when the machine is turned on, and flashes when the machine enters the sleep mode (power-saving mode) or the machine’s software is being updated.
- ④ **Home Button**
Displays the home screen (starting screen for operating this machine).
- ⑤ **Feed Button**
Feeds the loaded mat in to or out from the feed slot. Be sure to press this button to feed the mat when loading or unloading it.
- ⑥ **Pause/Stop Button**
Stops or pauses operation being performed by the machine.

Included Accessories

For details on the included accessories, refer to the “Included Accessories” insertion.

Removing the Packing Materials

Before turning on the machine, open the front tray cover, and then remove all shipping tapes (in front and back of the machine) and the cardboard shock-absorbing material.

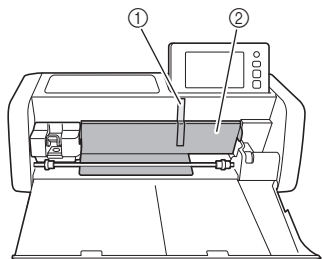

- ① Shipping tape
- ② Cardboard shock-absorbing material



Note

- If the packing materials were removed after the machine was turned on, turn the machine off, then on again. Continuing to use the machine without restarting it may result in incorrect operation.

Turning On/Off the Machine

- 1 Connect the power cord to the machine.

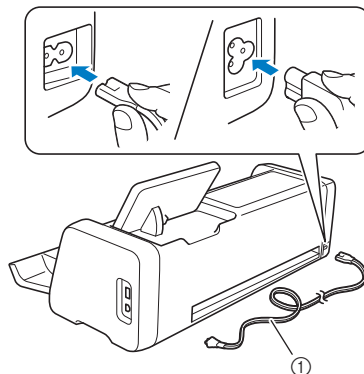

- ① Power cord

- 2 Plug the power cord into an electrical outlet.

- 3 Press  in the operation panel.

When the opening screen appears, touch anywhere on the display.

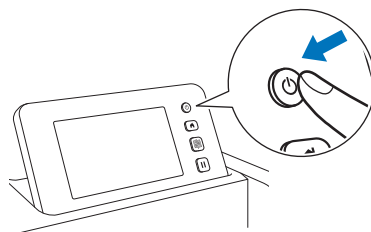

- ▶ When the following message appears, touch the "OK" key.

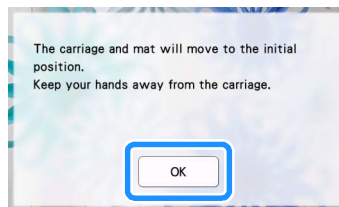

- ▶ The home screen appears.

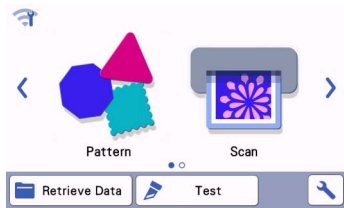

Memo

- LCD panels commonly have bright spots (permanently lit dots) and dark spots (unlit dots). It may cause some unexpected luminous spots to appear and tiny picture elements to be missed in the screen. Please note that this is not a sign of malfunction.

- 4** To turn off the machine, press  in the operation panel.
- 5** Unplug the power cord from the electrical outlet.
- 6** Disconnect the power cord from the machine.

Preparing for Feeding the Mat

- 1** Pull out the rear tray.

Before using the machine, be sure to pull out the rear tray.

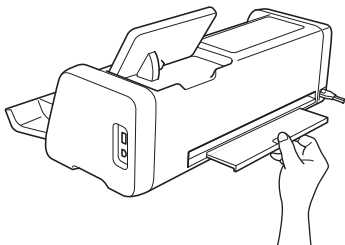

- 2** Raise the scanner lever (on the left side of the machine) to "2".

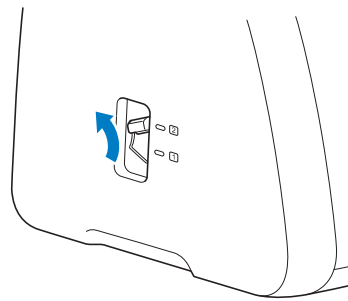

Memo

- Before scanning thin material, set the lever to "1". Leaving the lever raised may result in blurred scans.

Operation of LCD Panel

After the machine is turned on, the operation screens appear in the touch panel. To perform operations in the screens, use the included touch pen (stylus).

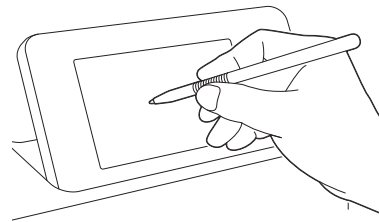

Note

- Never use a hard or pointed object, such as a mechanical pencil or screwdriver, to make a selection on the screens. Otherwise, damage to the machine may result.

Settings Screen

From the LCD panel, touch  to select and adjust the settings for each function.

This section contains descriptions of the machine settings which will appear when  is selected on the home screen.

■ Group 1

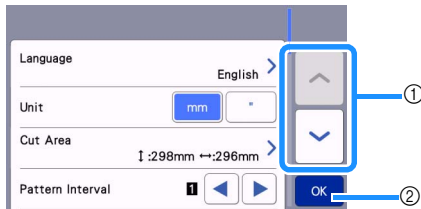

① Touch to display the previous or next item.

* Swiping the touch pen (stylus) over the screen will also display a different screen.

② Touch to finish specifying settings.

Language

Select the display language. Touch this button, select the desired display language, and then touch the “OK” key.

Unit

Select either millimeters or inches as the displayed measurement units.

Cut Area

Specify the area for cutting/drawing according to the size of material to be used. Touch this button, and then touch and drag the area resizing keys to specify the area. When using a 12" × 24" (305 mm × 610 mm)

mat, touch  to select a larger mat size, and then specify the area size. When using a 12" × 12"

(305 mm × 305 mm) mat, touch .

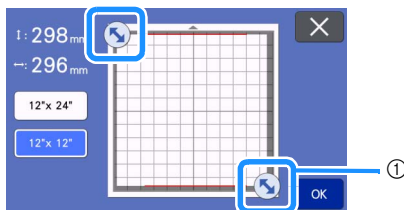

① Area resizing key (Using the touch pen (stylus), touch the key, and then drag it around the screen to specify the area.)

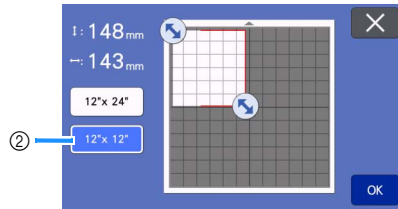

② Mat size key

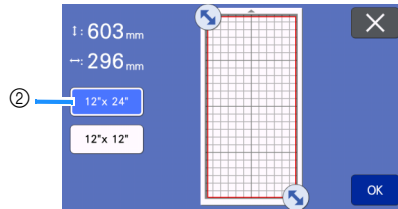

- Touch the “OK” key to apply the settings.

Touch  to return to the previous screen without applying the settings.

Pattern Interval

Specify the spacing between patterns as well as white space around the edges of cutting area when patterns on the mat layout screen are automatically arranged. The larger the number setting, the further spacing between patterns.



- Set the pattern interval to “3” or higher when lightweight fabric is attached to the mat with a high tack adhesive fabric support sheet.

Background

Adjust the contrast of a background image scanned with the background scanning function. For details, see “Scanning a Background Image” on page 50.

■ Group 2

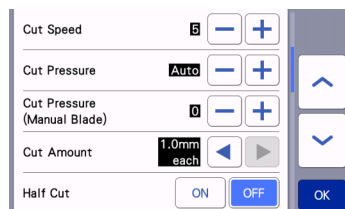

Cut Speed

Adjust the cutting speed.

Cut Pressure

Adjust the cutting pressure.

Cut Pressure (Manual Blade)

Specify the cutting pressure when the optional manual blade is used.

Cut Amount

Specify the cutting depth. Adjust the blade cut amount when a pattern with a sharp corner is cut from soft, thick material.

Half Cut

Select whether or not to make half-cuts. For details, see “Half Cut (Kiss Cut) Settings” on page 28.

Cut Pressure (Half Cut)

Specify the cutting pressure for half-cuts.

Blade Adjustment Area

Select from 1/4, 1/2, 3/4 or whole cutting area to be used for blade adjustment. Before cutting out a pattern, this machine performs an automatic blade adjustment, which adjusts the direction of the blade outside of the adhesive area of the mat.

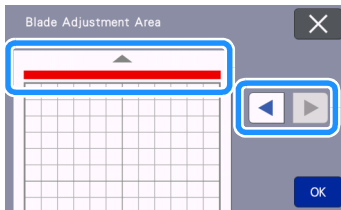

- With each press of the left or right arrow key, the size of the blade adjustment area changes by 1/4.

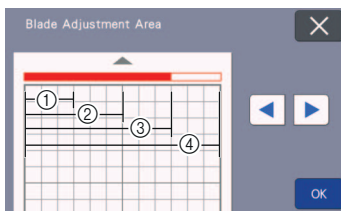

- ① 1/4
- ② 2/4
- ③ 3/4
- ④ Entire area

Draw Speed

Adjust the drawing speed.

Draw Pressure

Adjust the drawing pressure. Adjustments to the drawing pressure will affect the finished product. Use the same material that the pattern will be drawn on to make the adjustments in advance. If the pressure is too high, the pen tip may be damaged. Adjust the pressure appropriately.

■ Group 3



Seam Allowance

Specify the seam allowance. This is applied when drawing on fabric, then cutting it, for example, when making quilt pieces. For details, see “Cutting Around Drawings” on page 63.

Memo

- When multiple patterns are cut at the same time, the setting specified in this screen is applied to all patterns.
- If cutting line data saved with a different seam allowance is imported and used, the setting specified in this screen will have priority over the saved setting.

Fill

Select the design that will be used to fill patterns. For details, see “Using Drawing Functions to Fill Patterns/Make Outlines Thicker” on page 67.

Additional Line

With [Number of Additional Line], specify the number of lines to be added. With [Additional Line Spacing], specify the spacing of the lines to be added.

Memo

- For details for Fill and Additional Line setting, refer to “Using Drawing Functions to Fill Patterns/Make Outlines Thicker” on page 67.

■ Group 4

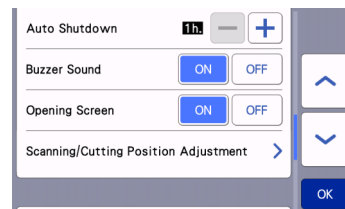

Auto Shutdown

Specify the length of time for the auto shutdown function. The setting can be specified in 1-hour increments. For details, see “Auto Shutdown” on page 12.

Buzzer Sound

Select whether or not an operation sound is produced, for example, when a key is touched.

Opening Screen

Select whether the opening slide show is displayed after the machine is turned on. If the slide show is displayed, touch the screen to display the home screen.

Scanning/Cutting Position Adjustment

The scanning/cutting position can be adjusted. To adjust the position, touch this button to display the settings screen. For details, see “Adjusting the Scanning/Cutting Position” on page 92.

■ Group 5



No.

Displays the number for this machine.

Ver.

Displays the version information for this software. Touch this button to update the machine's software. For details, see "UPDATING THE SOFTWARE" on page 102.

Machine Information

Touch this button, this page displays machine information.

■ Group 6

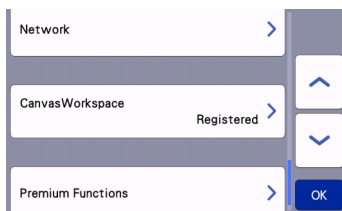

Network

Touch this button to set up a wireless network. For details, refer to "Wireless Network Setup Guide".



- The wireless network connection can also be set up by touching  in the home screen.

■ Group 7

CanvasWorkspace

Touch this button to specify settings for registering the machine with CanvasWorkspace. These settings are necessary in order to transfer patterns via a wireless network connection. For details, refer to "Wireless Network Setup Guide".

■ Group 8

Premium Functions

Activate optional accessories and specify settings for their functions.

Auto Shutdown

If the machine is not used for a specified length of time, it will automatically turn off. The length of time until the machine turns off can be specified in the settings screen.

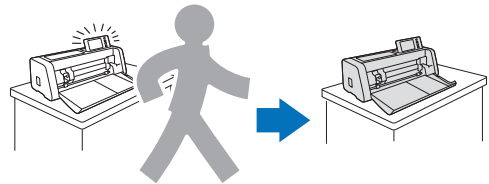

If the machine is automatically turned off after you reach the mat layout screen, the stored information can be recalled when the machine is turned on again. Following the instructions in the message screen that appear when the machine is turned on again, touch the "OK" key to display the mat layout screen or touch the "Cancel" key to return to the home screen.

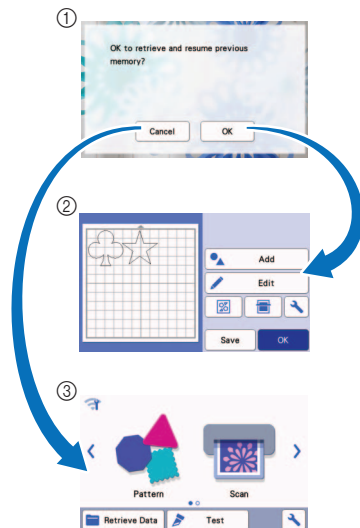

- ① Message screen
- ② Mat layout screen
- ③ Home screen

If the machine is automatically turned off before you reach the mat layout screen, the home screen will be displayed when the machine is turned on again.

Chapter 2 BASIC OPERATIONS

FIRST STEPS

The following procedures describe basic operations, from preparing the material to performing trial cutting.

1. **Selecting the Mat Appropriate for the Material**.....P.13
2. **Attaching the material to the mat**.....P.16
3. **Selecting the Blade Appropriate for the Material**P.23
4. **Installing the Holder in the Machine**.....P.24
5. **Trial Cutting (Test Cut)**.....P.25

Selecting the Mat Appropriate for the Material

Refer to the following table and the “Reference Table of Mat and Material Combinations” on page 14 for the appropriate mat and sheet for fabric cutting according to the material to be used for cutting or drawing. Depending on the machine model, some accessories listed in the chart may not be included. In that case, they must be purchased separately.

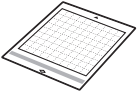
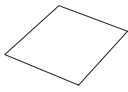
 Mat		 Sheet for fabric cutting	
Standard tack adhesive mat	Our standard tack adhesive mat has a high adhesive strength for use with cutting. * Use the low tack adhesive mat with copy paper and smooth paper. Since the standard tack adhesive mat has a high adhesive strength, materials may remain stuck to the mat, causing the mat to become unusable.	Iron-on fabric appliqué contact sheet (white backing) (See page 17)	<ul style="list-style-type: none"> Reinforces the fabric so that various patterns can be cut out. Original texture may change because it remains attached to the back of fabric. * For use with the standard tack adhesive mat. * Do not place fabric backed with iron-on contact sheet directly onto a mat with high tack fabric support sheet.
Low tack adhesive mat	Low adhesive mat; suitable for copy paper and smooth paper.	High tack adhesive fabric support sheet (See page 20)	<ul style="list-style-type: none"> For best results when cutting fabric, attach the high tack adhesive fabric support sheet to the standard tack adhesive mat in order to increase the strength of the adhesive. Depending on the shape, the pattern may not be cleanly cut.

Reference Table of Mat and Material Combinations

Use a mat appropriate for the material, as referred to in this table. Before using materials from your project, test attaching the material to check the adhesion to the mat.

	Material	Thickness	Mat (for ScanNCut DX)		Sheet for fabric cutting	
			Standard Tack Adhesive Mat	Low Tack Adhesive Mat	Iron-on Fabric Appliqué Contact Sheet (White Backing)	High Tack Adhesive Fabric Support Sheet
Paper	Printer paper	80 g/m ² (0.1 mm)	⊘	✓		
	Scrapbook paper (thin)	120 g/m ² (0.15 mm)		✓		
	Scrapbook paper (medium-thick)	200 g/m ² (0.25 mm)	✓	✓*		
	Cardstock	280 g/m ² (0.35 mm)	✓	✓*		
	Vellum, tracing paper	0.07 mm		✓		
	Poster board	400 g/m ² (0.5 mm)	✓	✓		
Fabric	Thin cotton fabric (for quilt piece)	0.25 mm	✓			✓
	Thin cotton fabric (except for quilt piece)	0.25 mm	✓		✓	
	Flannel (for quilt piece)	0.5 mm	✓			✓
	Flannel (except for quilt piece)	0.5 mm	✓		✓	
	Felt	3 mm	✓		✓	
	Denim 14 oz	0.75 mm	✓		✓	
Others	Plastic sheet (PP)	0.2 mm	✓			
	Vinyl	0.2 mm	✓			
	Magnet	0.3 mm	✓			
	Sticker or seal	0.2 mm	✓	✓		
	Foam sheet	3 mm	✓			

✓* When cutting paper with a smooth surface

Memo

- When using a 12" × 12" (305 mm × 305 mm) mat, the maximum work area for cutting/drawing is 296 mm × 298 mm (11.65" × 11.73").
- When using an optional 12" × 24" (305 mm × 610 mm) mat, the maximum work area for cutting/drawing is 296 mm × 603 mm (11.65" × 23.74").
- Some fabrics with uneven surfaces can be cut if turned upside down.

- Avoid using craft paper or fabric covered with decorative layer (that can easily separate), such as lamé or foil. The separate layer may stick to the machine's scanning device or feed rollers during operation, resulting in damage to the machine. It may also damage the cutting blade. When using such material, be sure to clean the scanner glass inside the machine after every use (page 91).
- Tape material that can easily peel off, such as foam sheets, to secure it in place.
- Be careful since tape with an extremely high adhesive strength may damage the mat.
- Do not affix masking tape, etc., over the scanning marks. Otherwise, the mat may not be correctly recognized or images may not be correctly scanned.

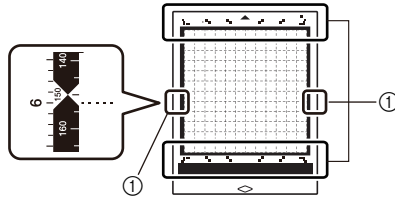

① Scanning marks

- Do not affix tape on both long edges of the cutting mat as it may attach to the feed rollers during operation.
- Do not attach any material that will go beyond the adhesive area of the mat as the auto blade holder may not recognize the material thickness and may not accurately cut the material.

Attaching the material to the mat

After preparing the mat and sheet (when cutting fabric) appropriate for the material, attach the material to the mat. For the mat and sheet appropriate for the material, see “Reference Table of Mat and Material Combinations” on page 14.



Note

- Do not discard the protective sheet peeled off the mat; save it for later use.
- In order to maintain the adhesive strength, attach the protective sheet to the adhesive side of the mat after use.
- When the mat is not being used, clean the adhesive side and affix the protective sheet before storing it. For details, see “Cleaning the Mat” on page 89.

Material
“Paper” on page 16
“Fabric (Other Than for Quilt Piecing)” on page 17
“Fabric (for Quilt Piecing)” on page 20

■ Paper

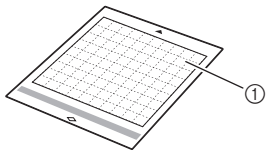

① Mat suitable for the material

□ Attaching the Material (Paper)

- 1 Peel off the protective sheet from the adhesive side of the mat.

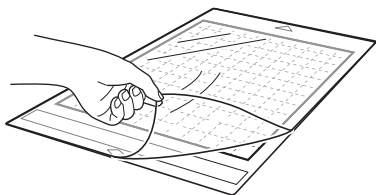

2

Test attaching the material.

Before attaching the material to the mat, use a corner of the adhesive side of the mat to test attaching it. If any of the following problems occur when test attaching, the adhesive strength of the mat is too high for the material. Use different material.

- When the material is peeled off, color from the material remains on the mat.
- When the material is peeled off, it tears or is deformed.

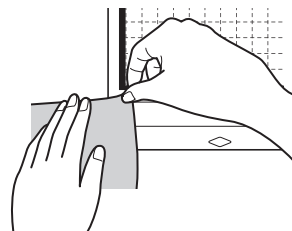

Note

- Use the low tack adhesive mat with copy paper and smooth paper. Since the standard tack adhesive mat has a high adhesive strength, materials may remain stuck to the mat, causing the mat to become unusable

3

Attach the material to the mat’s adhesive side.

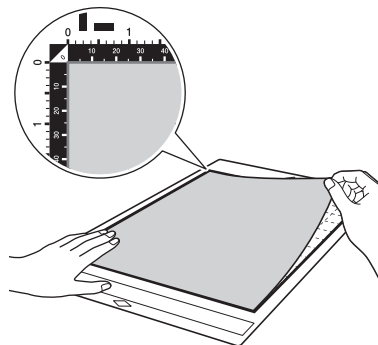

Note

- Place the material within the attaching area (grid area) on the adhesive side. If the material extends from the attaching area, it may be caught on the feed rollers when the mat is fed, damaging the machine.
- Insert the mat into the machine in the direction of the arrow. Pay attention to the mat’s orientation to avoid inserting the mat in the wrong direction.

4 Firmly attach all of the material to the mat so that there are no wrinkles and no part can curl off.

- Otherwise, curls in the material may become caught when the mat is inserted.

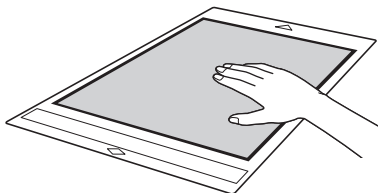

Note

- If the mat is dirty, clean it. For details, see “Cleaning the Mat” on page 89.

□ Peeling Off the Material (Paper)

After cutting the material, use a spatula to slowly peel off the paper.

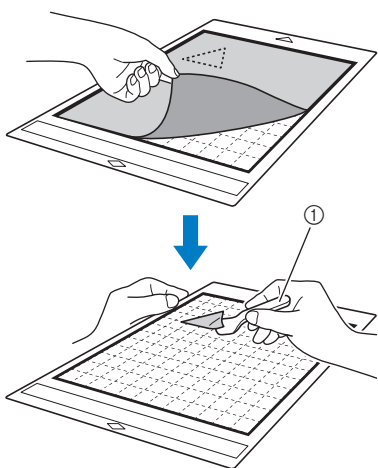

- ① Spatula



Note

- When peeling off the material, insert the spatula as level as possible into the space between the material and mat. Strongly rubbing the adhesive side of the mat may damage it.

■ Fabric (Other Than for Quilt Piecing)

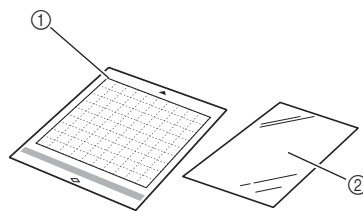

- ① Standard tack adhesive mat
- ② Iron-on fabric appliqué contact sheet (white backing)

□ Attaching Fabric Material (Excluding Quilt Piecing)

Iron the specially designed contact sheet to the back of fabrics (excluding quilt piecing) and then attach them to the standard tack adhesive mat. The double-faced adhesive type of the iron-on fabric appliqué contact sheet reinforces the fabric and enables any pattern to be cut easily, including appliqués. The sheet cannot be removed once it has been attached to the back of fabrics.

For Quilt Piecing, use the high tack adhesive fabric support sheet and avoid using the iron-on fabric appliqué contact sheet. For details on using fabric for quilt piecing, see “Fabric (for Quilt Piecing)” on page 20.



Note

- The contact sheet may not adhere to a fabric surface that is so rough that the two surfaces cannot be heat-set to adhere to each other.

1 Peel off the protective sheet from the adhesive side of the standard tack adhesive mat.

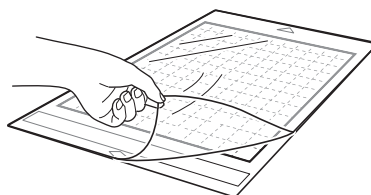

- 2** Cut the iron-on fabric appliqué contact sheet to a size 2 cm (3/4") or more larger than the outline of the pattern to be cut.

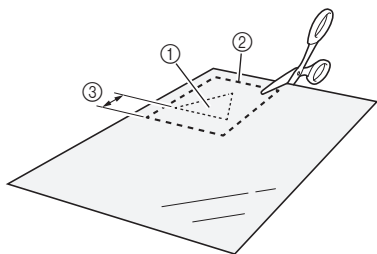

- ① Pattern to be cut
- ② Cutting line of sheet
- ③ Margin of 2 cm (3/4") or more

- 3** With the glossy side of the contact sheet facing down, place it on the wrong side of the fabric.

Be sure to first iron the fabric to remove any wrinkles. Before placing the contact sheet on the fabric, make sure that the fabric has been allowed to cool after ironing.

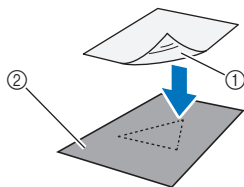

- ① Glossy side of contact sheet
- ② Wrong side of fabric

- 4** Evenly iron the entire contact sheet to affix it to the wrong side of the fabric.

With the iron on a medium temperature setting (140 °C to 160 °C (284 °F to 320 °F)), press each part of the sheet for about 20 seconds (the length of time differs depending on the material).

Be sure to apply pressure on the top of the backing and push out any air between the sheet and fabric.

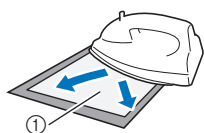

- ① Backing



Note

- Before attaching the contact sheet to the fabric, use a piece of the sheet to test attach it. If any problems occur when test attaching, use different material.
- Leaving the iron in the same place for too long may scorch or melt the material.

- 5** Peel off the backing from the contact sheet.

Before peeling off the backing, allow all parts to cool.

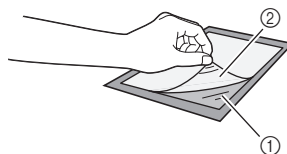

- ① Contact sheet
- ② Backing

- 6** With the side of the fabric that the contact sheet is attached to facing down, attach the material to the mat from its edges.

Slowly attach the entire surface of the material from its edges while pressing out any air with a ruler, etc., so that no air is trapped between the mat and the material.

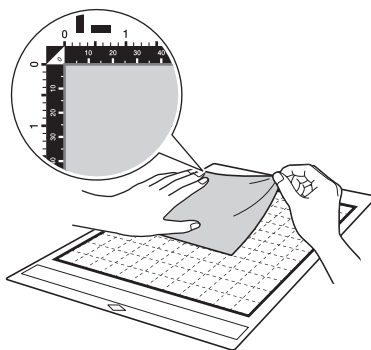

Note

- Place the material within the attaching area (grid area) on the adhesive side. If the material extends from the attaching area, it may be damaged by the feed rollers when the mat is fed.
- Insert the mat into the machine in the direction of the arrow. Pay attention to the mat's orientation to avoid inserting the mat in the wrong direction.



Memo

- Be sure that the vertical grain of the attached fabric runs straight up and down. The built-in patterns are automatically arranged suitable for fabric with vertical grain.

- 7** Firmly attach all of the material to the mat so that there are no wrinkles and no part can curl off.

- Otherwise, curls in the material may become caught when the mat is inserted.

❑ Peeling Off the Material (Excluding Quilt Piecing)

After cutting the material, use a spatula to peel off the fabric together with the attached contact sheet.

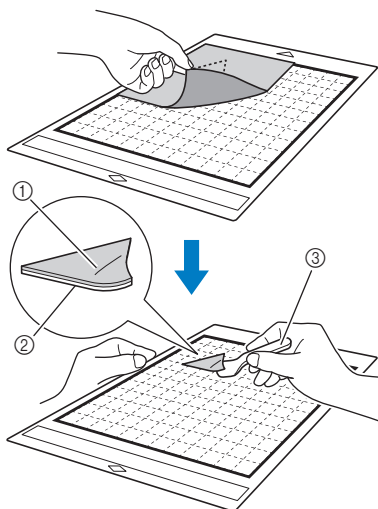

- ① Pattern that was cut out
- ② Contact sheet
- ③ Spatula

Note

- Do not place anything heated on the fabric attached with a contact sheet. Adhesive will permeate any other pieces of fabric around.
- When peeling off the material, insert the spatula as level as possible into the space between the material and mat. Strongly rubbing the adhesive side of the mat may damage it.

❑ Attaching Fabrics With the Double-Sided Adhesive

Place a cutout on a base fabric and apply pressure on the top of the cutout using an iron. (The contact sheet may not adhere well to some fabrics.) Hand or machine stitch to ensure that the cutout stays in place.

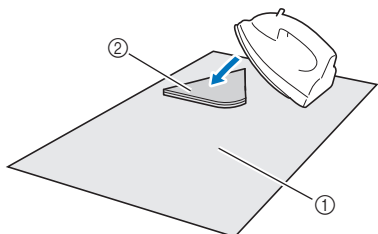

- ① Base fabric
- ② Cutout with a contact sheet

Note

- Do not wash fabrics attached together with a double-sided adhesive contact sheet.
- When attaching fabrics with the double-sided adhesive, iron carefully, being sure that the material and adhesive surfaces are properly heat-set.
- When attaching fabrics of different weights with the double-sided adhesive, first iron the lighter-weight fabric to affix the contact sheet.
- When attaching fabric with an iron-on sheet attached or paper to the mat, cleanly peel off the support sheet from the mat, or attach the material to a different standard tack adhesive mat without a support sheet attached.

❑ Notice on Use of Iron-on Fabric Appliqué Contact Sheet

- Store the contact sheet at room temperature and in a location not exposed to high temperatures, high humidity or direct sunlight.

■ Fabric (for Quilt Piecing)

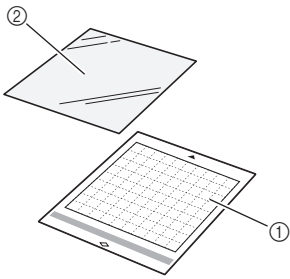

- ① Standard tack adhesive mat
- ② High tack adhesive fabric support sheet

□ Attaching the Material (for Quilt Piecing)

Use the high tack adhesive fabric support sheet to attach fabrics for quilt piecing to the standard tack adhesive mat. These sheets should only be used with patterns that have a seam allowance. The high tack adhesive fabric support sheet can be repeatedly used until their adhesive strength has decreased. (Once the support sheet has been peeled off the mat, it can no longer be used.)

- 1 Peel off the protective sheet from the adhesive side of the standard tack adhesive mat.

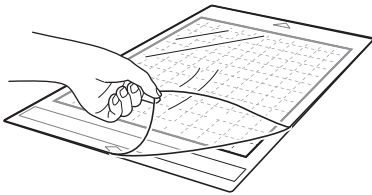

- 2 With the glossy side of the high tack adhesive fabric support sheet facing down, attach it to the mat's adhesive side.

Slowly attach the entire surface of the support sheet from its edges while pressing out any air with a ruler, etc., so that no air is trapped between the mat and the sheet.

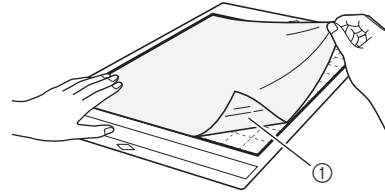

- ① Glossy side of support sheet



Note

- Place the support sheet within the attaching area (grid area) on the adhesive side of the mat. If the sheet extends from the attaching area, it may be damaged by the feed rollers when the mat is fed.

- 3 Peel off the backing from the top of the support sheet.

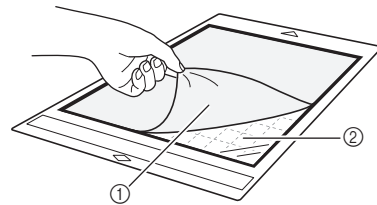

- ① Backing
- ② Adhesive

- 4 Test attaching the material.

Before attaching the material to the mat, use a corner of the adhesive side of the mat to test attach it. If any problems occur when test attaching, the adhesive strength of the mat is too high for the material. Use different material.

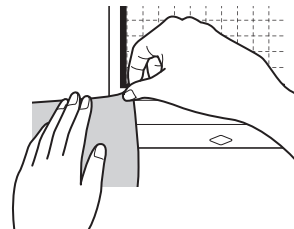

- 5** From its edges, attach the material to the adhesive side of the mat so that there are no wrinkles in the material.

Be sure to first iron the fabric to remove any wrinkles.

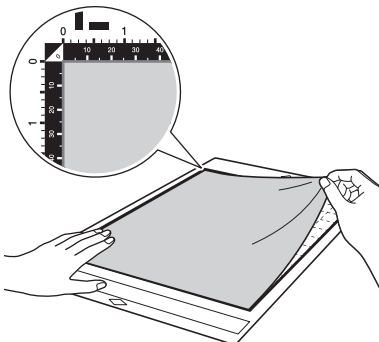

Note

- Place the material within the attaching area (grid area) on the adhesive side. If the material extends from the attaching area, it may be damaged by the feed rollers when the mat is fed.
- Insert the mat into the machine in the direction of the arrow. Pay attention to the mat's orientation to avoid inserting the mat in the wrong direction.

Memo

- Be sure that the vertical grain of the attached fabric runs straight up and down. The built-in patterns are automatically arranged suitable for fabric with vertical grain.
- When drawing a seam allowance, attach the fabric to the mat with its wrong side facing up.

- 6** Firmly move the spatula handle across the surface of the fabric to remove any wrinkles and firmly attach the fabric to the mat.

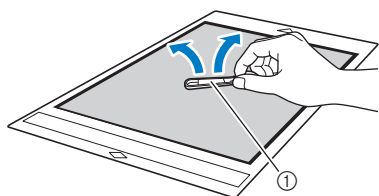

- ① Spatula

Peeling Off the Material (Fabric for Quilt Piecing)

After cutting the material, use a spatula to slowly peel off just the fabric. Try not to peel off the support sheet.

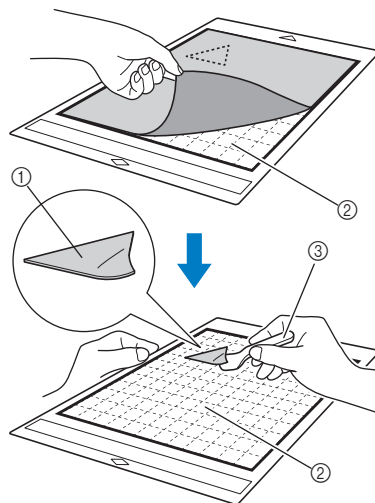

- ① Fabric cut out
- ② Support sheet remaining on mat
- ③ Spatula

Note

- The support sheet may be unintentionally peeled off while you are removing the fabric from the mat under the following conditions:
 - The adhesive between the mat and support sheet is becoming weak after repeated uses.
 - The support sheet tends to be strongly attached to a certain types of fabrics.
- In this case, use the included spatula to hold the support sheet on the mat and remove the fabric using your hand.
- After cutting, carefully remove any fibers remaining on the support sheet.
- Do not leave material attached to a mat with a support sheet attached for a long period of time; otherwise, the adhesive will permeate the material.
- When peeling off the material, insert the spatula as level as possible into the space between the material and mat. Strongly rubbing the adhesive side of the mat may damage it.

❑ Notice on Use of High Tack Adhesive Fabric Support Sheet

- When the sheet's adhesive strength decreases or fabric becomes twisted while being cut, replace the sheet with a new one.
- When peeling the sheet off the mat or replacing the sheet, use the spatula to carefully remove the old sheet.
- Store the mat in between uses with the protective sheet affixed to the support sheet.
- If a mat with a support sheet attached is not to be used for a certain length of time, peel the support sheet off the mat and affix the protective sheet on the adhesive side of the mat before storing it.
- Do not reuse a support sheet that has been attached to the mat.
- Store the support sheet at room temperature and in a location not exposed to high temperatures, high humidity or direct sunlight.
- Do not bend the support sheet to store it.
- We recommend attaching it to a new cutting mat.

Blade and Material Combination

The appropriate blade differs depending on the material type and thickness. Before cutting the material, be sure to perform test cut (trial cut). For details on trial cutting, see “Test Cut (Trial Cut)” on page 25.

Use the following table to select the appropriate cutting blade according to the material that will be cut.

Material compability may vary. Always perform a test/trial cut to confirm a successful cut.

If you need additional help, the Brother Solutions Center offers the latest FAQs and troubleshooting tips.

Visit us at “ <http://s.brother/cpoac/> ”.

		Material	Thickness	Auto blade holder	
				Auto Blade (Black)	Thin Fabric Auto Blade (Beige)
Paper	Printer paper	80 g/m ² (0.1 mm)	✓		
	Scrapbook paper	200 g/m ² (0.25 mm)	✓		
	Cardstock	280 g/m ² (0.35 mm)	✓		
	Vellum, tracing paper	0.07 mm	✓		
	Poster board	400 g/m ² (0.5 mm)	✓		
Fabric	Thin cotton fabric (for quilt piece)	0.25 mm		✓	
	Thin cotton fabric (except for quilt piece)	0.25 mm	✓		
	Flannel (for quilt piece)	0.5 mm		✓	
	Flannel (except for quilt piece)	0.5 mm	✓		
	Felt	3 mm	✓		
	Denim 14 oz	0.75 mm	✓		
Others	Plastic sheet (PP)	0.2 mm	✓		
	Vinyl	0.2 mm	✓		
	Adhesive Craft Vinyl (backing sheet : 0.1 mm)	0.07 mm	✓		
	Magnet	0.3 mm	✓		
	Sticker or seal	0.2 mm	✓		
	Sticker Sheet (backing sheet : 0.15 mm)	0.15 mm	✓		
	Foam sheet	3 mm	✓		

- Use a high tack adhesive fabric support sheet or a iron-on fabric appliqué contact sheet when you cut a piece of fabric out. For details, see “Reference Table of Mat and Material Combinations” on page 14.
- Depending on the model, the thin fabric auto blade may not be included. In that case, it can be purchased as an optional accessory.



Note

- An auto blade holder is included with this machine. With this blade holder, the thickness of the material is detected, and the blade extension is automatically adjusted.
- Thick or hard material will automatically be cut multiple times.

Installing and Uninstalling the Holder

Select the holder appropriate for the material, and then install it into the machine. For details on the holder appropriate for the material, see “Blade and Material Combination” on page 23.

1 Press in the operation panel to turn on the machine.

For details, see “Turning On/Off the Machine” on page 8.



Note

- Be sure to turn on the machine before installing the holder.
- If the holder is installed while the machine is off, the blade may break and material may not be cut cleanly.

2 Remove the protective cap.

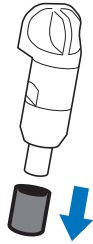

WARNING

- This is not a toy and is not intended to be used by children. In order to prevent choking hazards, do not allow infants/children to put the protective caps in their mouths.

CAUTION

- Please remove protective cap from blade holder before placing it into the machine carriage.
- Do not press the tip of the holder with your hand or fingers because the tip of the blade will extend and may result in injuries.

3 Grasp the holder grip, and then insert the holder into the carriage.

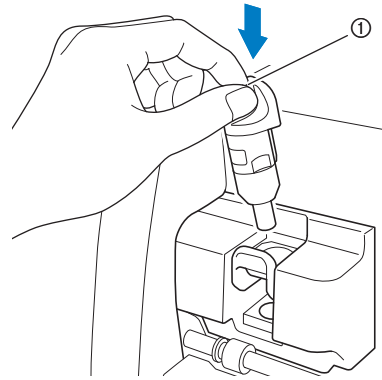

① Grip

4 Push down on the holder lock lever.

Firmly push down until the holder is locked in place.

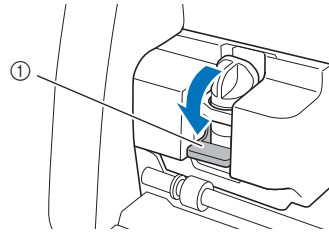

① Holder lock lever

5 Reverse the installation procedure to uninstall the holder.

WARNING

- This is not a toy and is not intended to be used by children. In order to prevent choking hazards, do not allow infants/children to put the protective caps in their mouths.

CAUTION

- After removing the blade holder from the machine, be sure to attach the protective cap.
- Do not press the tip of the holder with your hand or fingers because the tip of the blade will extend and may result in injuries.

Test Cut (Trial Cut)

Perform test/trial cut or draw on the type of material to be used in your project, to check that the desired result can be achieved.

This section describes the procedure for performing test cut.

■ Turning On the Machine

Press  in the operation panel to turn on the machine.

- For details, see "Turning On/Off the Machine" on page 8.

■ Setting the Holder

Install the cutting blade holder into the carriage of the machine.

- For details, see "Installing and Uninstalling the Holder" on page 24.

■ Selecting the Test Pattern

Cut out the test pattern.

- 1 Touch the "Test" key in the home screen.

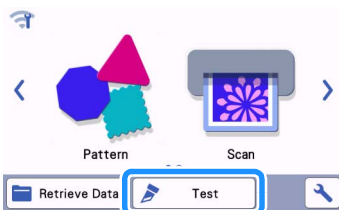

- ▶ The pattern is automatically arranged in the test screen.

Memo

- Test/trial cut can also be performed after selecting an operation in the preview screen, displayed after a pattern is selected. For details, see "Tutorial 1 - Cutting Patterns" on page 29.

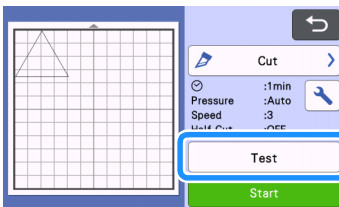

- 2 Check that the pattern to be cut out is arranged within a cutting area specified according to the size of the material.

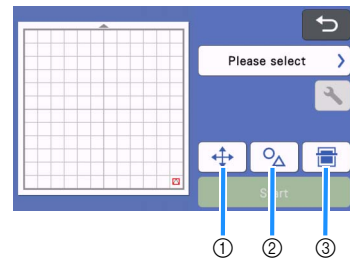

- 1 **Pattern Arrangement Key**
Touch to make adjustments in the mat editing screen when changing the arrangement of the pattern. If changes are applied to the pattern arrangement, the pattern will be automatically arranged in the same location the next time test/trial cut is performed.
- 2 **Size/Shape Adjustment Key**
Touch to adjust the pattern shape and size. For details on making changes, see step 3.
- 3 **Background Scanning Key**
Scan a background image. For details, see "Scanning a Background Image" on page 50.

- 3 To change the shape and size of the pattern, touch .

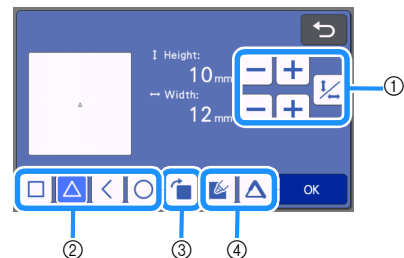

- 1 **Size Adjustment Keys**
Change the size of the pattern. For details, see "Pattern Editing Functions" on page 40.
- 2 **Test Pattern Selecting Keys**
Select the test pattern.
- 3 **Test Pattern Rotating Key**
Rotate the test pattern. Touch the key that shown in the screen for the desired angle to rotate the pattern. For details, see "Object Editing Screen" on page 43.
- 4 **Test Pattern Fill/Additional Line Setting Keys**
Select whether or not to fill or add lines to the test pattern. These functions are not available when you select the "Cut" or "Emboss" operation mode.

- ▶ Touch the "OK" key to return to the test screen.

■ Loading the Mat

1 Attach the material that will be cut to the mat.

- For details on attaching material to the mat, see “Attaching the material to the mat” on page 16.

2 While holding the mat level and lightly inserting it into the feed slot, press in the operation panel.

Insert the tip of the mat so that it aligns with the guides on the left and right sides of the feed slot and is tucked under the feed rollers. Insert the end of the mat marked with an arrow into the machine.

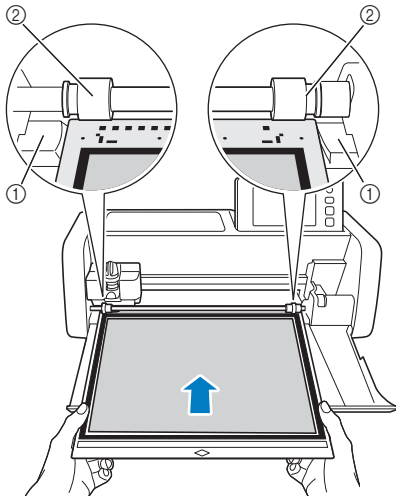

- ① Guides
- ② Feed rollers

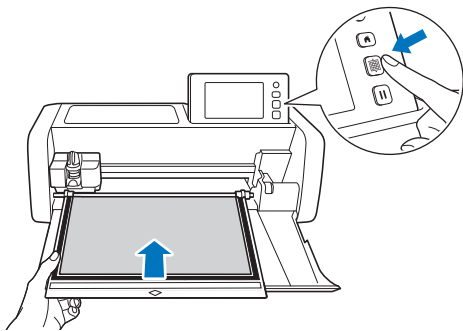

- ▶ The mat is fed in to complete the preparations for cutting.

Note

- Do not forcefully pull the mat while it is being fed in. Otherwise, damage, for example, to the feed rollers, may result.

■ Cutting

1 Select “Cut” in the test screen.

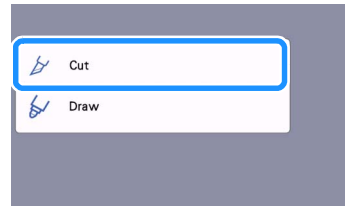

Note

- To make half cuts (kiss cuts), turn on half cut (kiss cut) in the settings screen. For details on specifying the settings, see “Half Cut (Kiss Cut) Settings” on page 28.

2 Touch the “Start” key to start cutting.

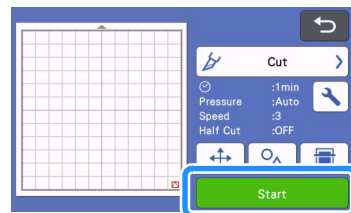

- ▶ When cutting is finished, the message “Finished cutting.” appears on the display. Touch the “OK” key to return to the test screen.

■ Unloading the Mat

- 1 Press  in the operation panel to feed out the mat.

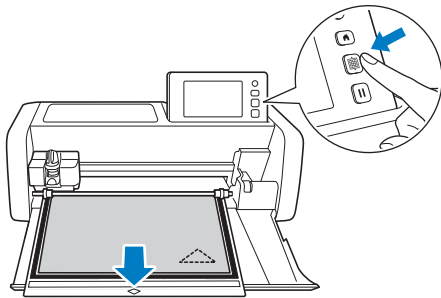

Note

- Do not forcefully pull the mat while it is being fed out. Otherwise, damage, for example, to the feed rollers, may result.

- 2 Peel off the material from an area that is easily removable, such as a corner, and then slowly peel while maintaining an even pressure.

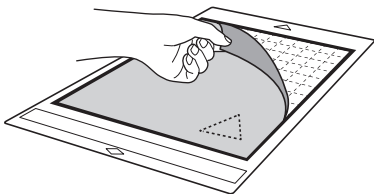

- 3 Holding the mat with your hand, use the included spatula to carefully peel off the cut-out patterns.

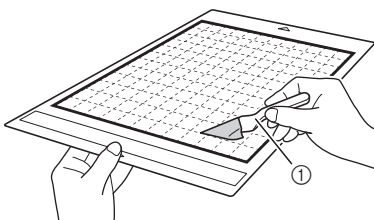

① Spatula

Note

- When peeling off the material, insert the spatula as level as possible into the space between the material and mat. Strongly rubbing the adhesive side of the mat may damage it.

■ Checking the Test/Trial Cut Results

Adjust the cutting pressure according to the test/trial cut results.
Repeatedly perform test/trial cut and adjust the cutting pressure until the material is cut cleanly.

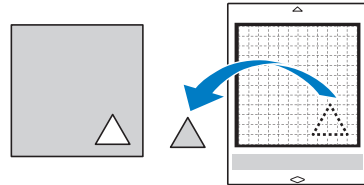

□ With an Appropriate Cutting Pressure

When the material is peeled off, a faint trace of the cut remains on the mat surface.



■ Changing the Auto Cutting Pressure

If the material could not be cut cleanly, refer to the following table, and adjust the setting for the cutting pressure.

Test/Trial Cut results	Tips for adjustment
Part of the pattern is not cut.	Pressure too light: Touch  in the settings screen once to increase the pressure.
The entire pattern is not cut.	Pressure too light: Touch  in the settings screen once to increase the pressure.
There are deep cuts completely through the mat.	Pressure too strong: Touch  in the settings screen once to decrease the pressure.

□ Changing the Cut Pressure Setting

- 1 Touch  in the test screen to display the settings screen.



- 2 Touch **+** or **-** to adjust the cutting pressure, and then touch the "OK" key.

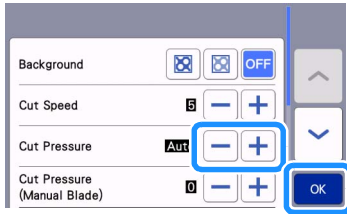

- 3 Check that the settings have changed in the test screen, and then perform test/trial cut again.

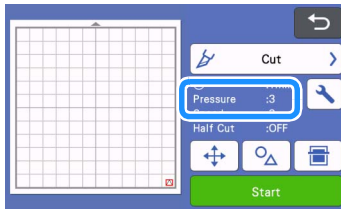

Note

- Be careful not to increase the pressure too much. Otherwise, the blade may break. If the pressure is too strong, the material may not be cut cleanly. In addition, the mat will deteriorate more quickly.

Half Cut (Kiss Cut) Settings

To make half cuts (kiss cuts), turn on half cut (kiss cut) in the settings screen before beginning to cut.

- 1 Touch  in the preview screen to display the settings screen.

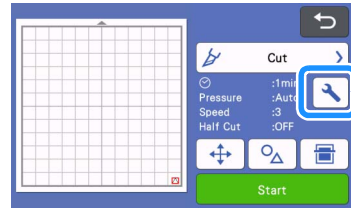

- 2 Turn on "Half Cut", and then touch the "OK" key.

- The pressure for half cut (kiss cut) can adjusted with "Cut Pressure (Half Cut)". Adjust the cutting pressure until half cut (kiss cut) result is as desired.

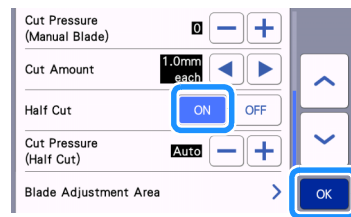

PATTERN CUTTING

The following procedures use built-in patterns to describe the entire series of operations, from selecting a pattern and editing it to cutting.

Tutorial 1 - Cutting Patterns

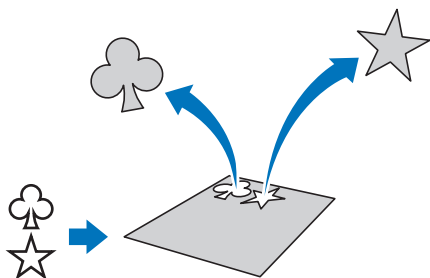

In this tutorial, we will cut two built-in patterns.

■ Turning On the Machine

Press to turn on the machine.

- For details, see “Turning On/Off the Machine” on page 8.

■ Setting the Holder

Install the cutting blade holder into the carriage of the machine.

- For details, see “Installing and Uninstalling the Holder” on page 24.

■ Selecting and Editing the First Pattern

1 Select “Pattern” in the home screen.

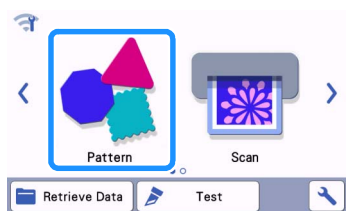

2 Select the category for the pattern to be cut out in the pattern category selection screen.

For this example, select .



- ① Touch to return to the previous screen.
- ② Pattern categories

Memo

- The pattern categories and built-in patterns that appear in the operation screens differ depending on the machine model. For details on the built-in patterns, refer to the “Pattern List”. The “Pattern List” can be downloaded from the Brother Solutions Center (<http://s.brother/cmoe/>).

3 Select the first pattern to be used in the pattern selection screen.



- ① Touch to scroll up.
- ② Touch to scroll down.

4 Edit the size and number of the pattern using the pattern editing screen.

After editing is finished, touch the “Set” key.

- For details on the editing functions, see “Pattern Editing Functions” on page 40.
- To select a different pattern, touch , cancel the selection, and then select a pattern again.

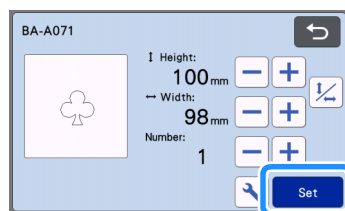

■ Selecting and Editing the Second Pattern

1 Touch the “Add” key in the mat layout screen.

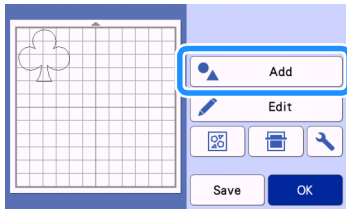

2 Select the location of the pattern to be added.

- For this example, touch the “Pattern” key to add a built-in pattern. For details on recalling pattern data, see step 3 in “Retrieve Data” on page 54.

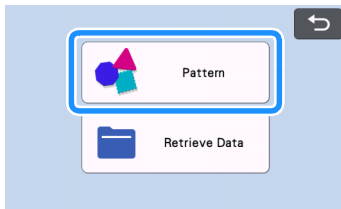

3 Select the category for the pattern to be cut out.



① Touch to return to the previous screen.

4 Select the second pattern to be used.



5 Edit the pattern.

After editing is finished, touch the “Set” key.

- For details on the editing functions, see “Pattern Editing Functions” on page 40.
- To select a different pattern, touch , cancel the selection, and then select a pattern again.

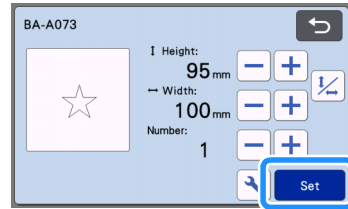

6 Check the pattern arrangement.

The two patterns that will be cut out appear in the mat layout screen. After checking the arrangement, touch the “OK” key.

- From this screen, an individual pattern can be edited, moved or deleted. For details on the functions that can be used in the mat layout screen, see “Layout Editing Functions” on page 42.
- By using the auto layout function, the arrangement of the patterns can easily be adjusted. For details, see “Auto Layout Functions” on page 49.
- Select the “Cut Area” setting appropriate for the mat being used. (See page 10.)

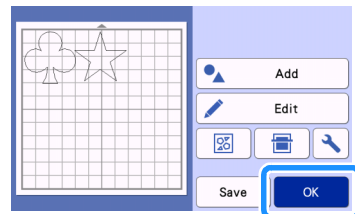

► The preview screen appears.

Note

- Depending on the pattern type and material to be cut, the patterns may not be cleanly cut if their spacing is too small. In that case, rearrange the patterns to separate them.

Memo

- To move a pattern within the cutting/drawing area, touch the pattern on the screen and drag it to the desired position.

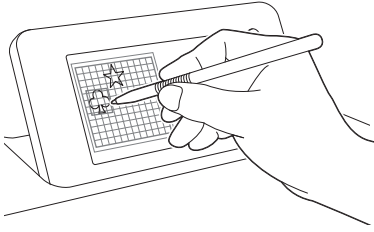

- To delete a pattern from the arrangement, select the pattern in the mat editing screen, and then use the function for deleting.
 - ▶ Touch the "Edit" key in the mat layout screen.
 - ▶ Touch the pattern to be deleted in the screen. To delete multiple patterns, use the function for selecting multiple patterns. For details, see "Selecting Multiple Patterns" on page 38.

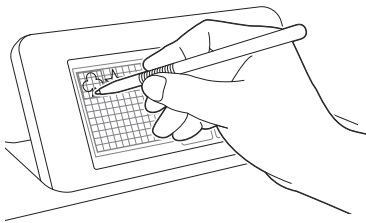

- ▶ Touch  in the mat editing screen to delete the selected pattern(s).

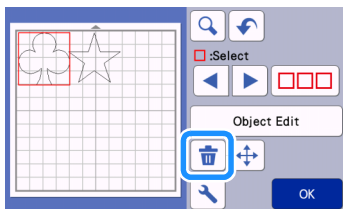

Loading the Mat

While holding the mat level and lightly inserting it into the feed slot, press  in the operation panel.

- For details, see "Loading the Mat" on page 26.

Cutting

- 1 Select "Cut" in the preview screen.

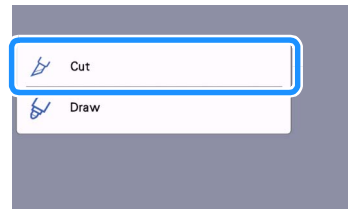
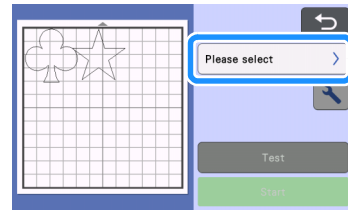

Note

- Before continuing operation, make sure that patterns that will be cut out are arranged in the cutting area corresponding to the size of the material to be used.
- To make half cuts (kiss cuts), turn on half cut (kiss cut) in the settings screen before beginning to cut. For details, see "Half Cut (Kiss Cut) Settings" on page 28.

- 2 Touch the "Start" key to start cutting.

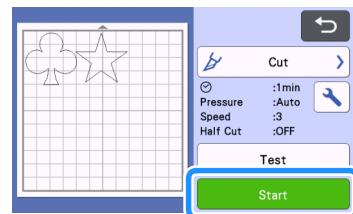

- ▶ When cutting is finished, the preview screen appears again.

Note

- Touch the “Test” key in the preview screen to perform test/trial cut. When test/trial cut is finished, the following screen appears.

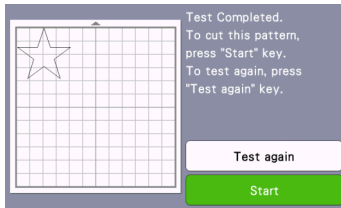

- Touch the “Start” key to start cutting the pattern.
- Touch the “Test again” key to return to the test screen. Change the settings, and then perform test/trial cut again.

■ Unloading the Mat

Feed out the mat, and then use the included spatula to peel off the patterns.

For details, see “Unloading the Mat” on page 27.

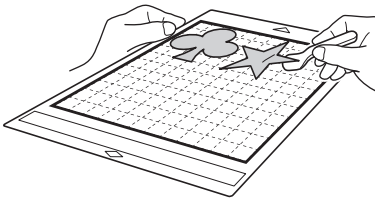

Tutorial 2 - Cutting Advanced Patterns

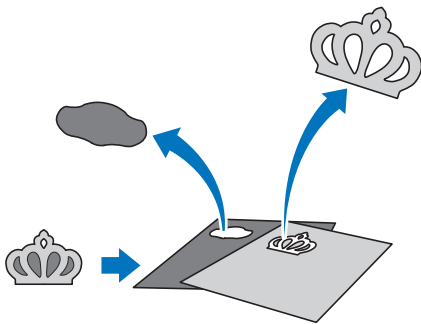

In this tutorial, we will cut a built-in pattern in the

 category.

■ Selecting and Editing the First Pattern Piece

- 1 Select “Pattern” in the home screen.

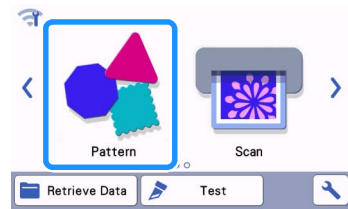

- 2 Select the category in the pattern category selection screen.



- ① Touch to return to the previous screen.
- ② Pattern categories

Memo

- The pattern categories and built-in patterns that appear in the operation screens differ depending on the machine model. For details on the built-in patterns, refer to the “Pattern List”. The “Pattern List” can be downloaded from the Brother Solutions Center (<http://s.brother/cmoe/>).

- 3 Select the sub-category in the pattern sub-category selection screen.



4 Select the pattern to be cut out in the pattern selection screen.

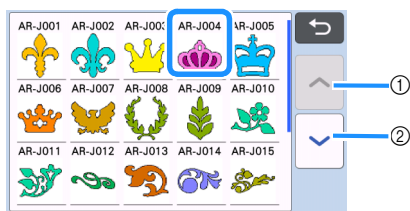

- ① Touch to scroll up.
- ② Touch to scroll down.

5 Edit the size of the entire pattern using the pattern sizing screen.

After editing is finished, touch the “OK” key.

- For details on the pattern sizing screen, see “Pattern Sizing” on page 41.

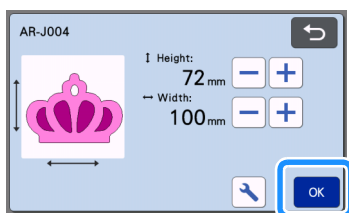

6 Select the piece to be edited first in the pattern piece list screen, and then touch the “OK” key.

From the pattern piece list that appears in the screen, touch a pattern piece to edit it individually.

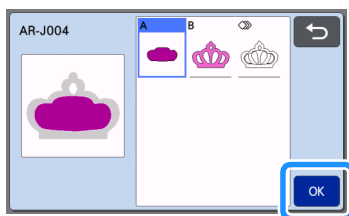
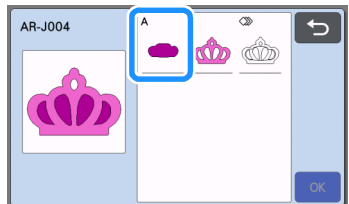

Memo

- The pattern pieces displayed in the pattern piece list screen are automatically arranged so that the grain is vertical when fabric is used as the material for cutting. Therefore, the angle at which the pattern appears in the pattern piece list may differ from the actual angle of the pattern piece to be cut out.

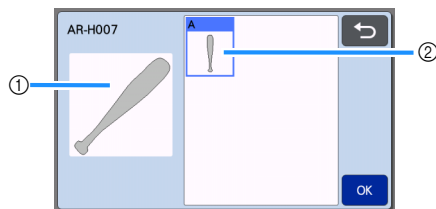

- ① Appearance in pattern piece list
- ② Actual arrangement of the pattern piece to be cut out
- Change the angle of pattern piece using the rotating function according to your project. For details, see “Editing the Pattern Piece” on page 41.
- A key showing all pattern pieces appears at the end of the pattern piece list. Press this key to select all pattern pieces and arrange them on the mat. This key is useful when cutting the pattern outline and cutting multiple pattern pieces within the same mat, see “Editing and Cutting the Second Pattern Piece” on page 35.

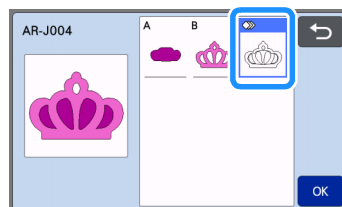

7 Edit the pattern piece using the pattern piece editing screen.

After editing is finished, touch the “Set” key.

- For details on the editing functions, see “Editing the Pattern Piece” on page 41.

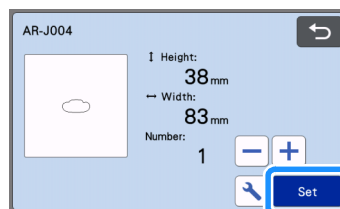

B Check the pattern piece arrangement using the mat layout screen.

The pattern piece to be cut out appears in the screen. After checking the arrangement, touch the "OK" key.

- From this screen, an individual pattern piece can be edited, moved, deleted or saved. For details on the editing functions in the mat layout screen, see "Mat Layout Screen" on page 41.
- Select the "Cut Area" setting appropriate for the mat being used. (See page 10.)

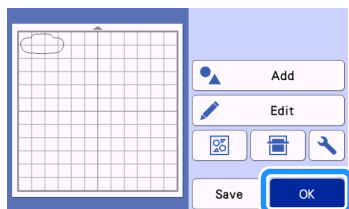

► The preview screen appears.

■ Loading the Mat

Attach the material that the first pattern piece will be cut out of to the mat, and then feed in the mat from the feed slot.

When cutting a pattern consisting of multiple pieces in different colors, edit the pattern piece for each color, and then change the material to cut out each piece.

- For details on preparing the material and loading the mat, see "Loading the Mat" on page 26.

■ Cutting the First Pattern

1 Select "Cut" in the preview screen.

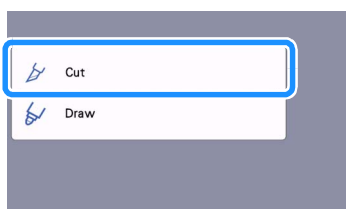
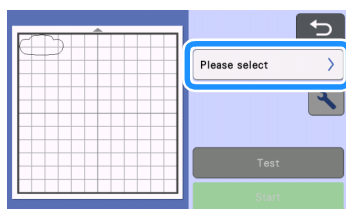

Note

- Before continuing operation, make sure that patterns that will be cut out are arranged in the cutting area corresponding to the size of the material to be used.
- To make half cuts (kiss cuts), turn on half cut (kiss cut) in the settings screen before beginning to cut. For details, see "Half Cut (Kiss Cut) Settings" on page 28.

2 Touch the "Start" key to start cutting.

- After the first pattern piece has been cut out, the following message appears. In order to cut out the second pattern piece, touch the "Select the next part" key.

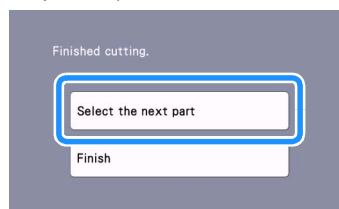

- Touching the "Select the next part" key erases all editing information for the first pattern piece and displays the pattern piece list screen again.

■ Unloading the Mat

1 Press in the operation panel to feed out the mat.

In order to replace the material with one of a different color, the material used for the first pattern piece must be fed out.

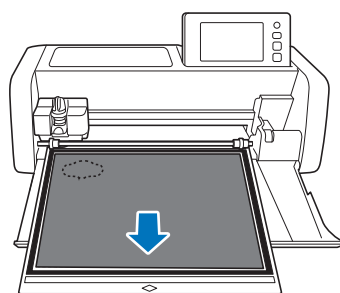

2 Peel from the mat the pattern piece that was cut out.

For details on peeling the material from the mat, see "Unloading the Mat" on page 27.

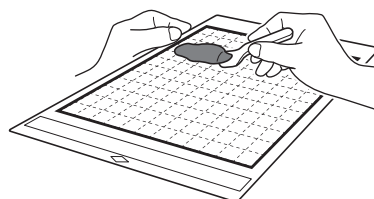

■ Editing and Cutting the Second Pattern Piece

- 1 Select and edit the second pattern piece, and then touch the "OK" key.

For details on editing the pattern, follow steps 6-B (page 33) in "Selecting and Editing the First Pattern Piece".

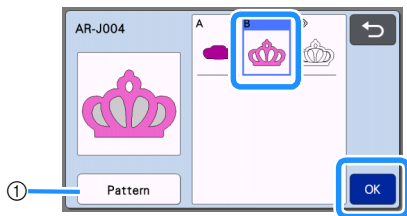

- ① Touch to return to the pattern category selection screen for selecting another pattern.

- 2 Follow the procedures described in "Loading the Mat" (page 26) and "Cutting" (page 26) to load the material to be used for the second pattern piece and cut it out.

▶ When cutting is finished, a message appears.

- 3 After all pattern pieces have been cut out, touch the "Finish" key.

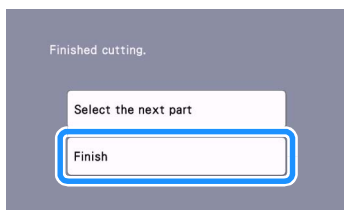

▶ The preview screen appears again.

■ Unloading the Mat

Peel from the mat the pattern piece that was cut out. For details on peeling the material from the mat, see "Unloading the Mat" on page 27.

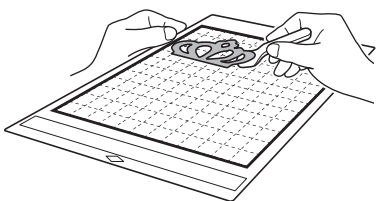

■ Editing and Cutting the all Pattern Pieces

□ Cutting the pattern outline

- 1 Select and edit the all pattern pieces, and then touch the "OK" key.

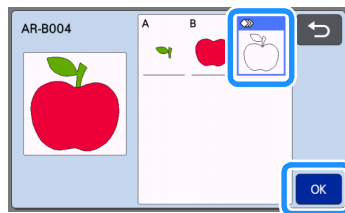

- 2 Edit the pattern piece using the pattern piece editing screen.

- For details on the editing functions, see "Editing the Pattern Piece" on page 41.

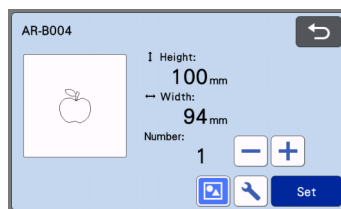

- 3 Touch  to ungroup the pattern pieces.

After editing is finished, touch the "Set" key.

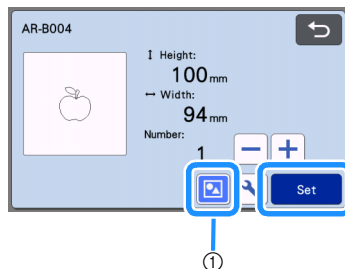

- ① Grouping/Ungrouping Key

Memo

- Grouping/Ungrouping patterns can also be adjusted in the object editing screen. For details, see "Grouping/Ungrouping Patterns" on page 44.

- 4 Check the pattern piece arrangement using the mat layout screen and then touch the "Edit" key.

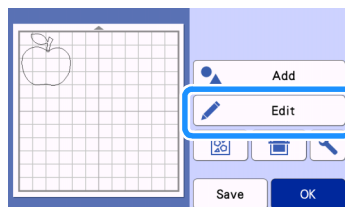

5 Touch the “Object Edit” key.

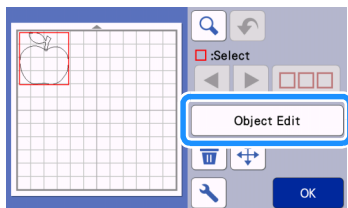

6 Touch  to weld the pattern.

- For details on the welding, see “Welding (Merging the Outlines of Multiple Patterns)” on page 46.

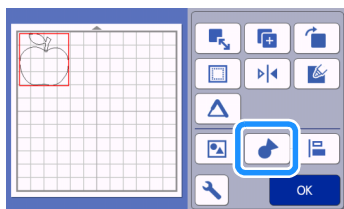

- ▶ Touch the “OK” key in the editing screen to return to the mat layout screen.

7 Touch the “OK” key.

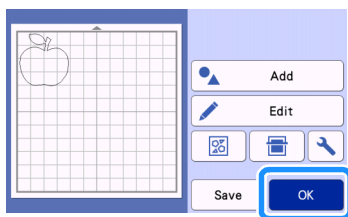

8 Follow the procedures described in “Loading the Mat” (page 26) and “Cutting” (page 26) to load the material to be cut.

- ▶ When cutting is finished, a message appears.

9 After all pattern pieces have been cut out, touch the “Finish” key.

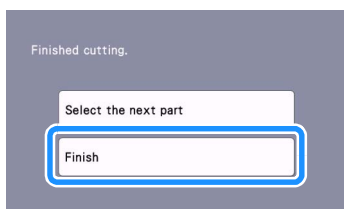

□ Cutting all the pattern piece within the same mat

1 Select and edit the all pattern pieces, and then touch the “OK” key.

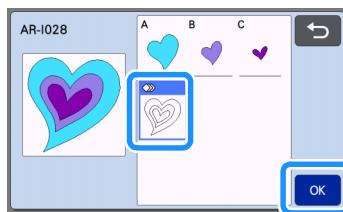

2 Edit the pattern piece using the pattern piece editing screen.

- For details on the editing functions, see “Editing the Pattern Piece” on page 41.

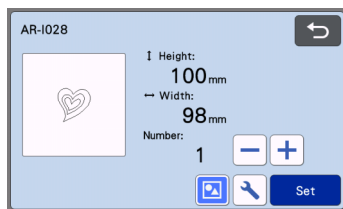

3 Touch  to ungroup the pattern pieces.

After editing is finished, touch the “Set” key.

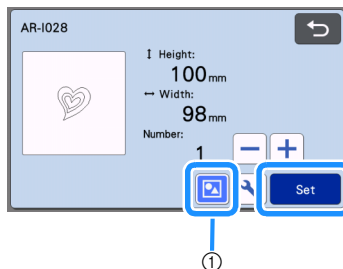

① Grouping/Ungrouping Key

4 Check the pattern piece arrangement using the mat layout screen and then touch  to arrange all the pattern pieces layout automatically.

- For details on the auto layout function, see “Auto Layout Functions” on page 49.

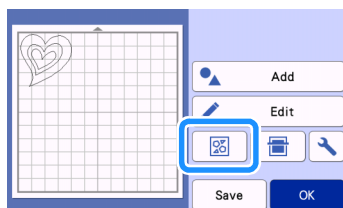

- ▶ Touch the “OK” key in the editing screen to return to the mat layout screen.

- 5 Touch the “OK” key.

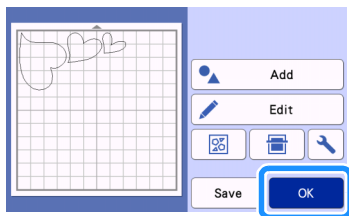

- 6 Follow the procedures described in “Loading the Mat” (page 26) and “Cutting” (page 26) to load the material to be cut.

► When cutting is finished, a message appears.

- 7 After all pattern pieces have been cut out, touch the “Finish” key.

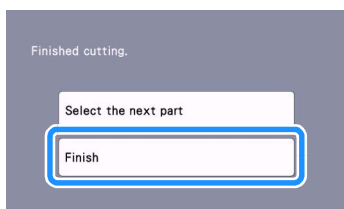

PATTERN SELECTION

The following four pattern selection functions are available in the mat editing screen depending on your preference:

- Selecting a Single Pattern
- Selecting Desired Patterns
- Selecting All Patterns
- Specifying the Selection Area
 - ▶ Touch the "Edit" key in the mat layout screen to use the pattern selection functions.

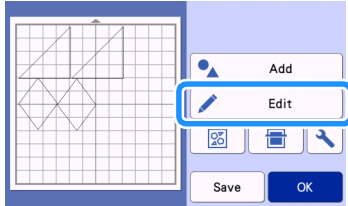

Selecting a Single Pattern

Select an individual pattern to be edited by either touching it in the editing screen or using ◀ and ▶, and then touch the "OK" key. The selected pattern is surrounded with a red box.

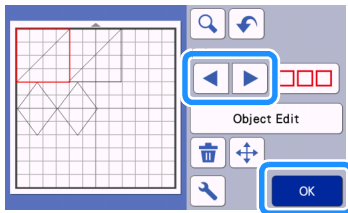

Selecting Multiple Patterns

■ Selecting Desired Patterns

- 1 Touch  in the mat editing screen for making multiple pattern selection.

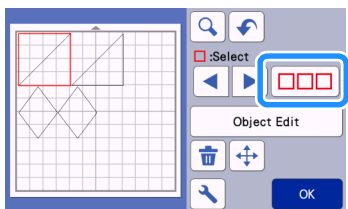

- 2 Individually touch all the patterns you want to select in the screen, and then touch the "OK" key.

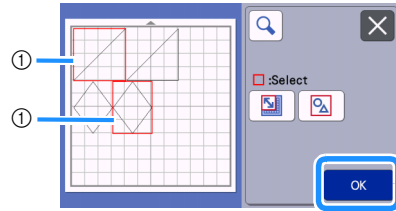



- ① Selected patterns

Memo

- Touching a selected (surrounded with a red box) pattern again clears its multiple selection.
- Touching any blank space in the screen clears all the pattern selections.

■ Selecting All Patterns

- 1 Touch  in the mat editing screen for making multiple pattern selection.
- 2 Touch  to select all the patterns on the screen.

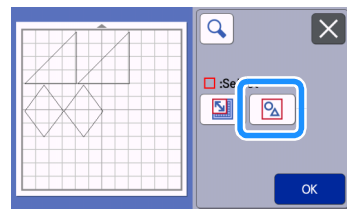

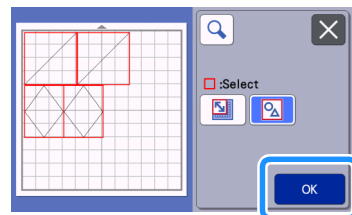

- 3 Check the selection, and then touch the "OK" key.

- ▶ All the selected patterns are surrounded with a red box.



■ Specifying the Selection Area

- 1 Touch  in the mat editing screen for making multiple pattern selection.
- 2 Touch  for specifying an area to select the patterns.

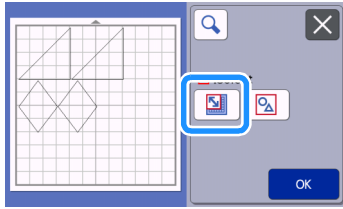

Memo

- Make sure that  is not selected before specifying the area to select.

- 3 Touch and drag the area resizing keys to specify the area, and then touch the “OK” key.

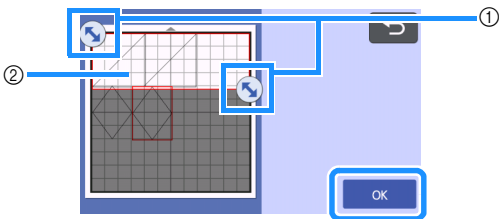

- ① Keys for specifying the area
- ② Patterns to be selected

Note

- Make sure to specify to include more than two patterns in the area.
- This method of selecting patterns within a specified area is useful for welding or unifying patterns and deleting unwanted images when scanning (page 46, page 80).

Chapter 3 ADVANCED OPERATIONS

CUTTING AND EDITING FUNCTIONS

Pattern Editing Functions

The pattern editing functions available may differ depending on the pattern you select. Follow the instructions in either this section or “Pattern Editing Functions - Multiple Patterns” on page 41.

Available in the following screen

Pattern editing screen → Tutorial 1; Step 4 (page 29) in “Selecting and Editing the First Pattern”

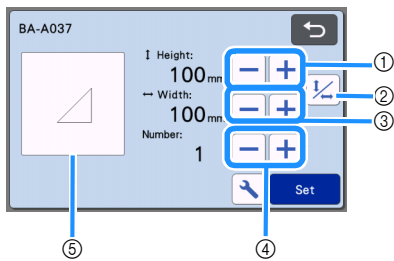

Note

- Depending on the pattern being used, the material may not be cut cleanly, if reducing the size of the pattern. Before making your project, perform test/trial cut with the same material.

① Sizing (Height)

Edit the pattern height while maintaining the aspect ratio. Touch **+** or **-** to adjust the setting. Touch  to edit only the height.

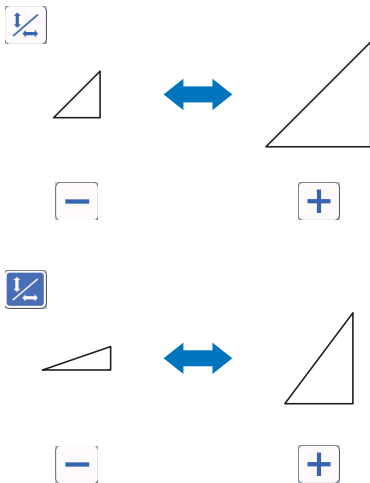

② Unlocking the Aspect Ratio

Touch  to edit the pattern size without maintaining the aspect ratio. The function is available depending on the pattern you select. If the key is not available, the aspect ratio is locked and the pattern can only be edited while maintaining the aspect ratio.

③ Sizing (Width)

Edit the pattern width while maintaining the aspect ratio. Touch **+** or **-** to adjust the setting. Touch  to edit only the width.

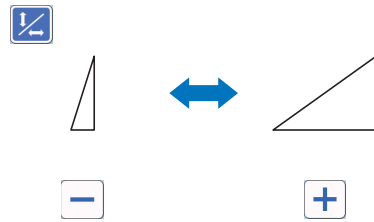

④ Duplicating (Pattern Quantity)

Create duplicate(s) of the selected pattern. Touch **+** or **-** to specify the pattern quantity.

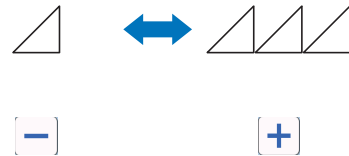

⑤ Previewing

Display a preview of the edited pattern.

Pattern Editing Functions - Multiple Patterns

The pattern editing functions available may differ depending on the pattern you select. Follow the instructions in either this section or “Pattern Editing Functions” on page 40.

■ Pattern Sizing

Available in the following screen

Pattern sizing screen	→Tutorial 2; Step 5 (page 33) in “Selecting and Editing the First Pattern Piece”
------------------------------	--

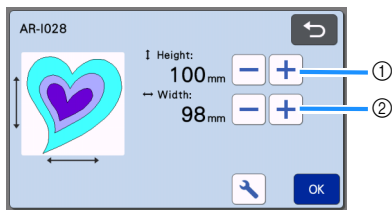

- ① Touch to edit the pattern height (while maintaining the aspect ratio).
- ② Touch to edit the pattern width (while maintaining the aspect ratio).

Memo

- All the pattern pieces displayed on the pattern sizing screen can be resized while maintaining the aspect ratio.

■ Editing the Pattern Piece

Available in the following screen

Pattern piece editing screen	→Tutorial 2; Step 7 (page 33) in “Selecting and Editing the First Pattern Piece”
-------------------------------------	--

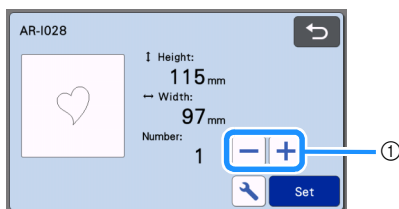

- ① **Duplicating (Pattern Quantity)**
For details, see “Pattern Editing Functions” on page 40.

Mat Layout Screen

The arrangement of the patterns can be edited. The cutting/drawing area specified with the “Cut Area” setting (page 10) in the settings screen is displayed in the preview screen. Edit the pattern arrangement so that the patterns fit within the specified area.

Available in the following screen

Mat layout screen	→Tutorial 1; Step 6 (page 30) in “Selecting and Editing the Second Pattern”
--------------------------	---

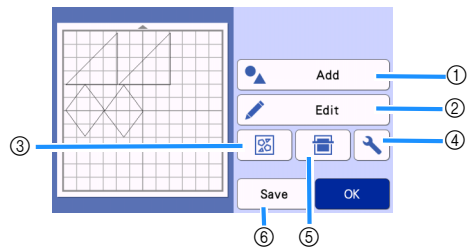

- ① **Adding Patterns**
Add a pattern to the layout.
 - ▶ Touching this key displays the selection screen for an additional pattern. From that screen, select the location of the pattern to be added.
- ② **Editing**
The patterns in the layout can be edited, moved or deleted. For details, see “Layout Editing Functions” on page 42.
- ③ **Auto Layout**
Automatically arrange the patterns to reduce their spacing. For details, see “Auto Layout Functions” on page 49.
- ④ **Settings**
Specify the cutting area, pattern spacing and background contrast. For details, see “Settings Screen” on page 10 or “Scanning a Background Image” on page 50.
- ⑤ **Background Scanning**
Scan the material for cutting/drawing to be displayed in the background of the mat layout screen. You can use specific areas of the material to cut out/draw patterns, or display the material that has already been cut in order to reuse it. For details, see “Scanning a Background Image” on page 50.
- ⑥ **Saving**
Save the pattern arrangement as data. For details, see “Saving” on page 53.

Layout Editing Functions

The layout editing functions are available when the "Edit" key is touched in the mat layout screen.

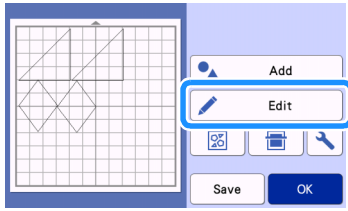

► The mat editing screen appears.

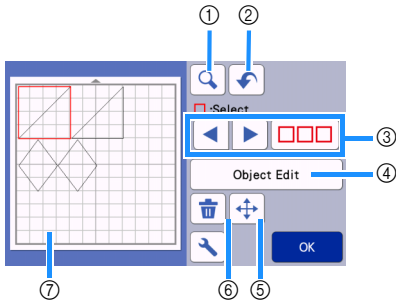

① Magnifying

Zoom in on the pattern at 200%. Then, touch

200% to display the patterns enlarged by 400%. To scroll through the screen, touch the arrow keys.

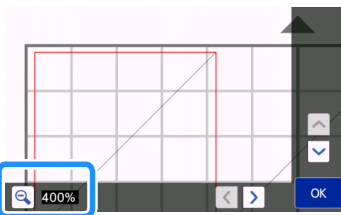
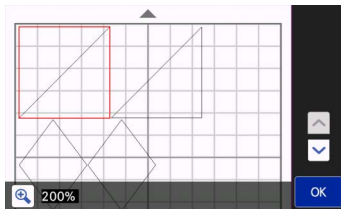

② Undoing an Operation

Undo the last operation to return to the previous condition. For details, see "Undoing an Operation" on page 44.

③ Selecting Patterns

Select an individual pattern or multiple patterns to be edited. For details, see "PATTERN SELECTION" on page 38.

④ Object Edit

The selected pattern can be edited in more detail. For details, see "Object Editing Screen" on page 43.

⑤ Moving

Incrementally move the selected patterns. Touch the arrow keys to adjust the position of the patterns.

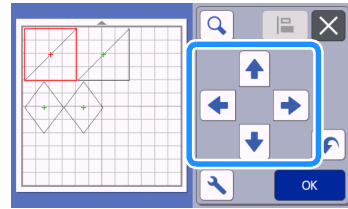

Memo

- The pattern can also be moved by touching it displayed in the layout editing screen and dragging it in the screen.
- To move a pattern while in the zoom mode, drag the pattern or touch the arrow key after selecting the pattern.
- Touch the arrow key once to move the selected pattern 0.5 mm (5 mm when the key is held down).

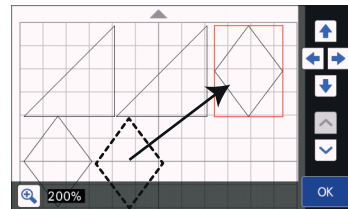

⑥ Deleting

Delete the selected patterns.

⑦ Previewing

Display a preview of the edited pattern.

Object Editing Screen

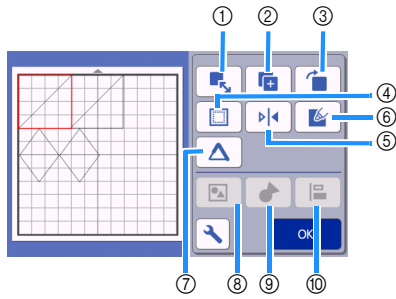

① Sizing

Change the size of the selected pattern.

- ▶ Touching this key displays the pattern sizing screen. From that screen, the height and width of the pattern can be changed.

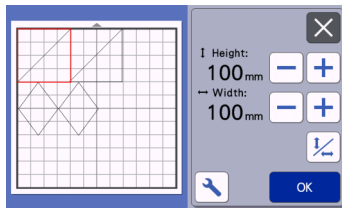

Note

- This function is not available when multiple patterns are selected.

② Duplicating (Pattern Quantity)

Create a duplicate of the pattern.

③ Rotating

Rotate the pattern.

- ▶ Touching this key displays the pattern rotation screen. From that screen, touch the key for the desired angle to rotate the pattern.

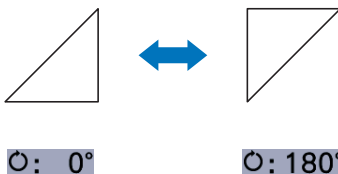
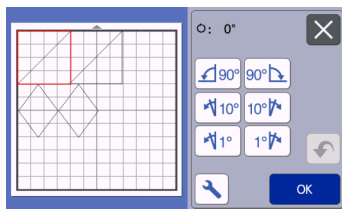

④ Seam Allowance

Apply the seam allowance setting. Apply this setting when cutting around a drawn pattern, such as when making appliqué or quilt pieces. When applied, the drawing line (blue) and cutting line (black) appear.

- For details on the seam allowance function, see “Cutting Around Drawings” on page 63.

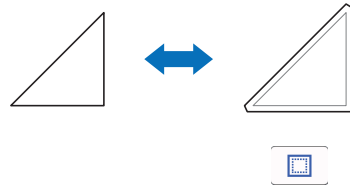

Memo

- Depending on the pattern, the seam allowance may be applied as a default. Check the setting.
- If the cutting line of a pattern extends from the cutting/drawing area due to editing, such as by applying a seam allowance or flipping a pattern, the line will become gray. Continue editing the pattern to move it within the cutting/drawing area.

⑤ Mirroring

Flip the pattern along a vertical axis.

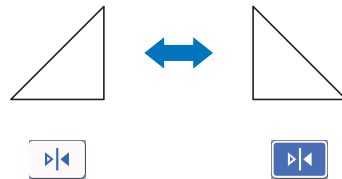

⑥ Fill

Select settings for filling patterns. For details, see “Using Drawing Functions to Fill Patterns/Make Outlines Thicker” on page 67.

⑦ Additional Line

Specify the number of lines to be added. For details, see “Using Drawing Functions to Fill Patterns/Make Outlines Thicker” on page 67.

⑧ Grouping/Ungrouping Patterns

When multiple patterns are selected, those patterns can be unified together and edited as a single pattern. This is useful for increasing or reducing the size of multiple patterns at one time. For selecting multiple patterns, touch  in the mat editing screen. For details, see “Grouping/Ungrouping Patterns” on page 44.

⑨ **Welding (Merging the Outlines of Multiple Patterns)**

Weld the outlines of multiple patterns to create a single outline. For details, see “Welding (Merging the Outlines of Multiple Patterns)” on page 46.

⑩ **Alignment**

Select multiple patterns to align them based on their positions or heights. For details, see “Aligning Patterns” on page 47.

Undoing an Operation

In the editing screen after patterns have been arranged in the mat, touch  to undo the previous operation.

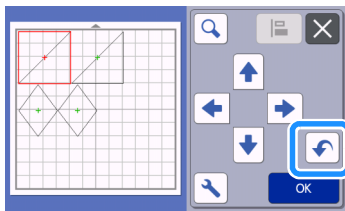

Memo

- Up to 10 of the previous operations can be undone.
- After an operation is undone, it cannot be redone.
- If the number of patterns has changed as a result of adding, removing, welding or unifying patterns, only operations after the number of patterns were changed can be undone.
- When patterns are automatically arranged, the operation cannot be undone.

Grouping/Ungrouping Patterns

Multiple patterns selected can be combined into a single group, or that group can be separated into the individual patterns.

(Under some conditions, it may not be possible to ungroup patterns. For the conditions where patterns cannot be ungrouped, refer to page 45.)

■ Grouping Patterns

1 Touch  in the mat editing screen, select the patterns to be grouped, and then touch the “OK” key.

- For details on selecting multiple patterns, see “Selecting Multiple Patterns” on page 38.

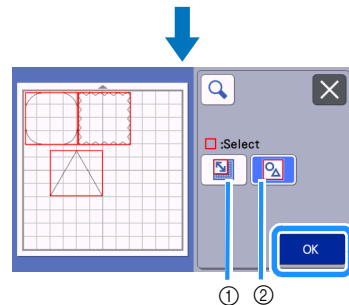
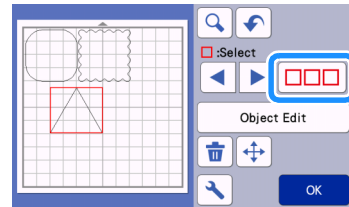

- ① Selects the patterns in the selection area.
- ② Selects all patterns in the layout.

2 Touch the “Object Edit” key in the mat editing screen.

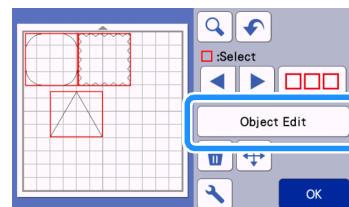



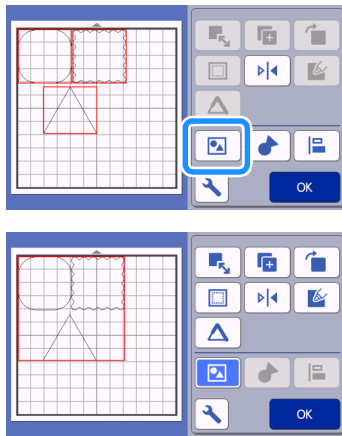

3 Touch  in the object editing screen.



▶ All of the selected patterns are grouped. (The color of the key changed.)

Memo

- The key color indicates how the selected patterns are grouped.
 - : Two or more patterns are selected and can be grouped. When the key is touched, it appears as .
 - : The patterns are grouped. (The color of the key changed.) When the key is touched, it appears as .
 - : Since two or more patterns are not selected, patterns cannot be grouped.
- Patterns cannot be grouped under the following conditions.
 - There is not enough of the machine's memory available.
 - Patterns with and without seam allowances have been selected.

■ Ungrouping Patterns

1 Select grouped patterns in the mat editing screen, and then touch the "Object Edit" key.

2 Touch  in the object editing screen.

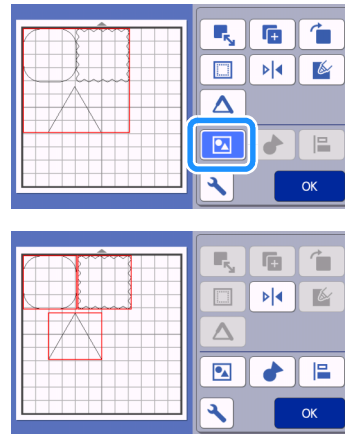

▶ The selected patterns are ungrouped. (The color of the key changed.)

Memo

- If  appears when patterns are selected, the patterns can be ungrouped.
- Grouped patterns are saved as one pattern. When the saved pattern is recalled, it cannot be ungrouped. When saving a pattern that contains grouped patterns, the following message appears.

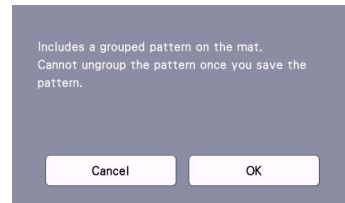

- Patterns cannot be ungrouped under the following conditions.
 - The number of patterns after being ungrouped exceeds the maximum number of patterns possible.
 - The pattern was retrieved from the resume memory after an auto shutdown.

Welding (Merging the Outlines of Multiple Patterns)

When multiple patterns are selected, the outlines of those patterns can be welded to create a single outline.

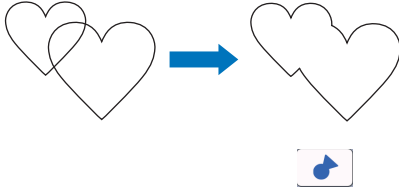

- 1 Select two heart patterns of different sizes and arrange them in the mat layout screen.
- 2 Touch the large heart pattern in the mat layout screen, and then drag it over the small pattern.

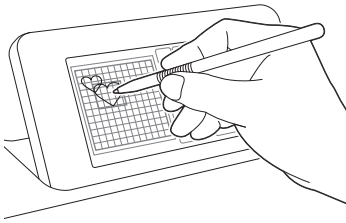

- 3 Touch  in the mat editing screen.
 - For details on the functions in the mat editing screen, see “Layout Editing Functions” on page 42.

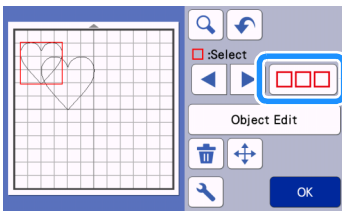

- 4 Select , and then touch the “OK” key.
 - Two pattern selection functions are available depending on your preference. For details on selecting multiple patterns, see “Selecting Multiple Patterns” on page 38.

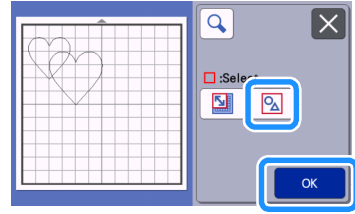

- 5 Touch the "Object Edit" key in the mat layout screen.

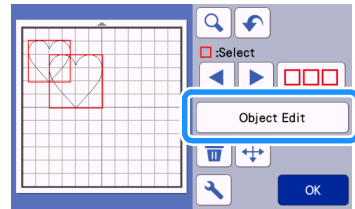

- 6 Touch  in the object editing screen.

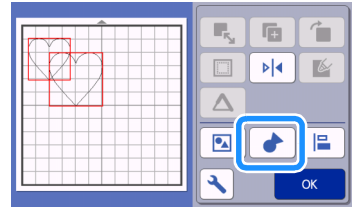

- 7 Check the preview, and then touch the “OK” key.

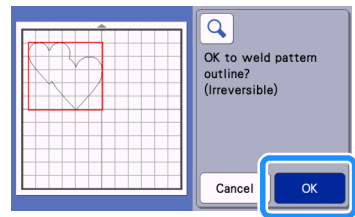

Note

- Welding pattern outlines cannot be undone. In order to recreate the original pattern arrangement, select the patterns again, and then arrange them.

- ▶ The outlines of the selected patterns are welded.

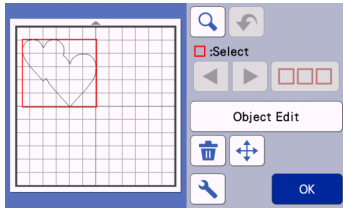

Note

- This function welds the outermost outline of the patterns. When welding certain types of patterns that have inside areas cut out, the cut-out areas are not used to create the outline. Be sure that the welded patterns in the preview area meet your wishes before completing the procedure.

- Welding built-in characters

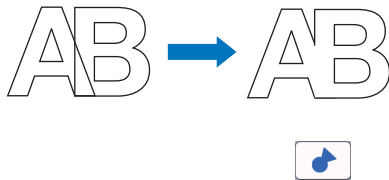

- Welding character images created by scanning

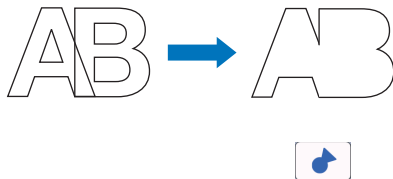

Aligning Patterns

Multiple patterns can be selected and aligned based on their positions or heights.

1 Select two or more patterns in the mat editing screen, and then touch the "Object Edit" key.

- For details on selecting multiple patterns, see "Selecting Multiple Patterns" on page 38.

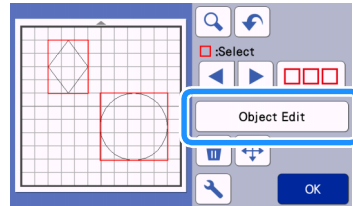

Memo

- The alignment key () can also be displayed in the pattern moving screen.

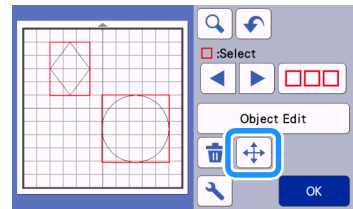

2 Touch in the object editing screen.

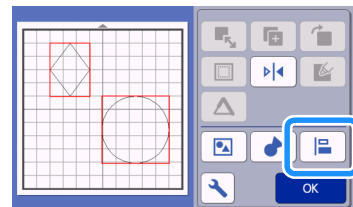

3 Align the patterns.

- The patterns are aligned depending on the key that is touched, as described below.

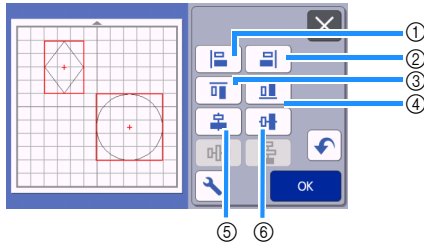

Original

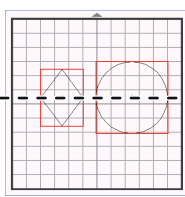
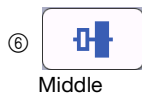
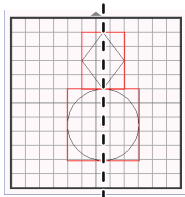
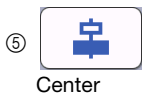
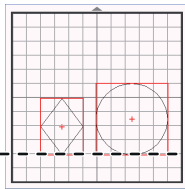
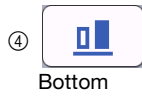
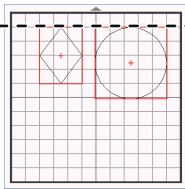
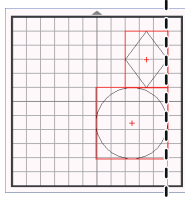
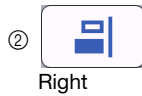
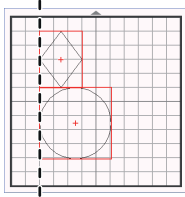
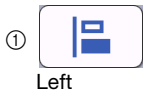
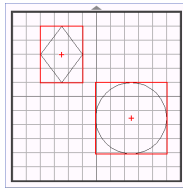

- If three or more patterns were selected, they can be distributed horizontally (7) or vertically (8).

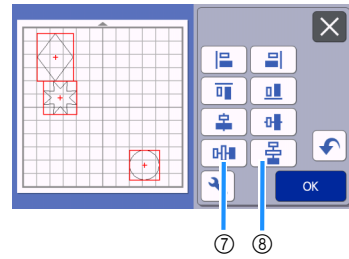

Original

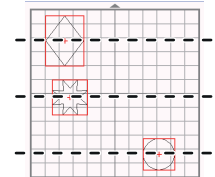
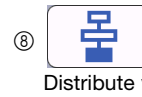
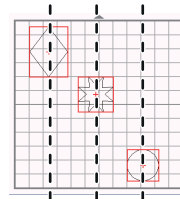
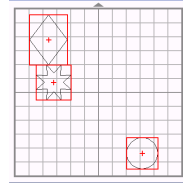

Note

- When patterns are distributed, they may extend out the mat. Adjust the pattern positions according to the message instructions.

4 Touch the "OK" key to return to the object editing screen.

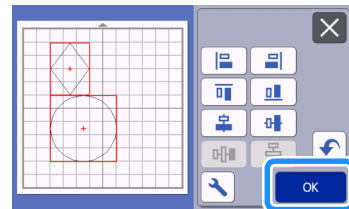

- Touch to return to the object editing screen without applying the pattern arrangement.

■ Centering Two or More Patterns

1 Add two circle patterns, and then change the size of one.

- For details on resizing patterns, see “Object Editing Screen” on page 43.

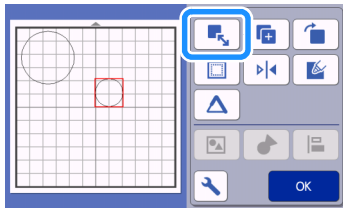

2 After selecting two patterns, touch in the object editing screen to display the following screen. After touching and to align the patterns, touch the “OK” key.

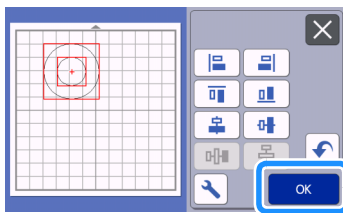
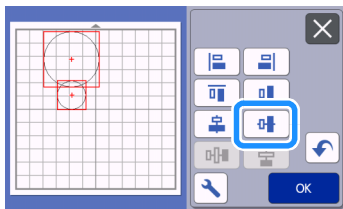
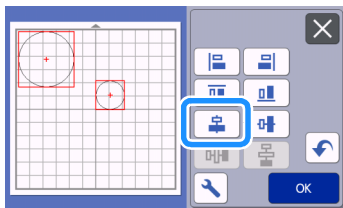

► The patterns are arranged.

Auto Layout Functions

The auto layout function is useful when you do not wish to waste the material attached to the mat.

Touch  in the mat layout screen (page 41) to perform the auto layout function.



Note

- Depending on the pattern and material to be cut, the patterns may not be cleanly cut if their spacing is too small. In that case, rearrange the patterns to slightly separate them.
- The spacing between arranged patterns can be specified in the settings screen (see “Pattern Interval” on page 10). Perform the auto layout function after every time you adjust the spacing between patterns so the changes are applied.
- Set the number to “3” or higher in the “Pattern Interval” setting when lightweight fabric is attached to the mat with a high tack adhesive fabric support sheet.

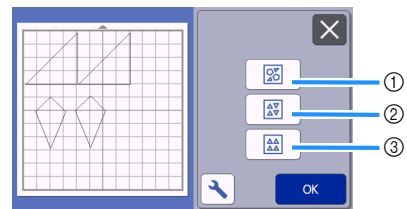

① Rearranging By Rotating Patterns to Any Angle

This is useful when arranging a large number of patterns in a limited space.

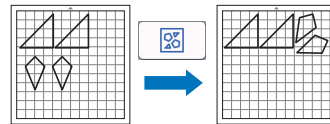

② Rearranging By Rotating Patterns 0° or 180°

This is useful when arranging the printed design (vertical patterns) on paper or fabric as the material for cutting/drawing or when using the vertical grain.

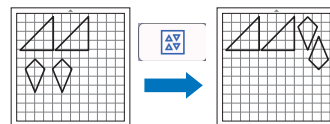

③ Rearranging Without Rotating Patterns

This is useful when arranging the printed design on paper or fabric as the material for cutting/drawing or when using the grain.

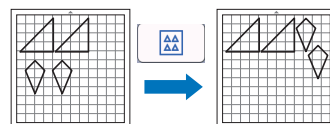

Scanning a Background Image

In this example, we will use material with a cutout in its upper-left corner as a background image.

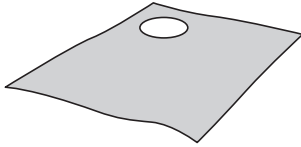

Memo

- The background scanning function is also useful when cutting out patterns from material with a design on it. By arranging the patterns on the screen in the desired patterned area of the material, cutouts with a specific design can be created.

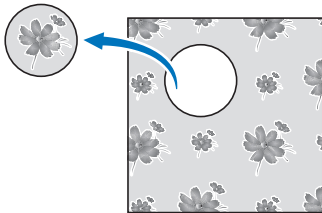

- This function cannot be used when an optional scanning mat is used.
- Depending on the machine model, the sizes of mats that can be used will differ. Check the "Maximum Scanning Area" under "Machine Information" of the settings screen. For details, refer to "Settings Screen" on page 10.

- Attach the material for the background to the mat, and then press  in the operation panel.**

For details on preparing the material and loading the mat, see "Loading the Mat" on page 26.

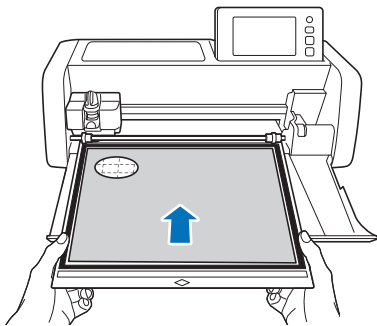

- After selecting the cutting/drawing pattern, touch  in the mat layout screen to start the background scanning function.**

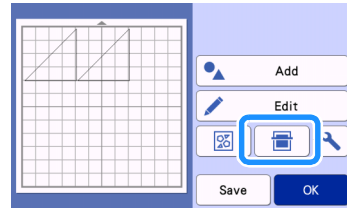

- The following message appears.

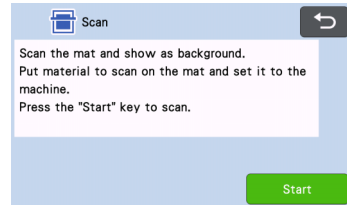

- Touch the "Start" key to start scanning.**

- After the material has been scanned, it appears as the background in the mat layout screen.

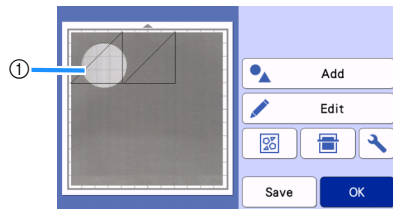



- Material with a cutout displayed as background

Memo

- If it is difficult to see the arranged patterns, adjust the background contrast in the settings screen. Touch  in the mat layout screen to display the settings screen.



-  : Makes the background image darker.
-  : Makes the background image lighter.
-  : Does not display the background image.

4 Touch the "Edit" key.

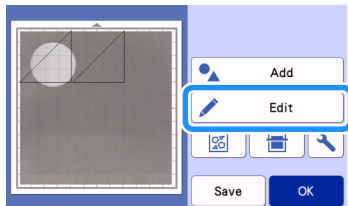

► The mat editing screen appears.

Memo

- The pattern can also be moved by touching and dragging it in the screen.

5 Use the layout editing functions to move the patterns.

- For details on moving patterns, see "Layout Editing Functions" on page 42.

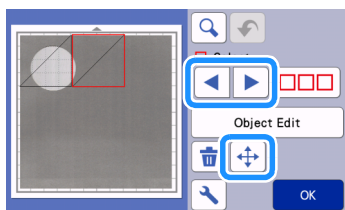

Memo

- The pattern can also be moved by touching the pattern(s) displayed in the layout editing screen and dragging it in the screen.

6 Check that the patterns in the screen do not overlap the cutouts in the background material and then touch the "OK" key.

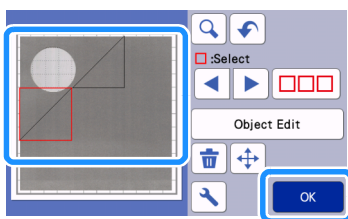

Memo

- When the scanned material is unloaded, the background is cleared.

Character Input Functions

Characters can be selected, edited, cut out and drawn as a single pattern. Select the character type from the pattern category selection screen.



- ① Select decorated characters. The characters can be edited, cut out and drawn as a pattern. For details on editing, see "Pattern Editing Functions" on page 40.
- ② Type in the desired combination of characters.

Typing In the Word "RAINBOW"

1 Select the font category in the pattern category selection screen.



2 Touch the desired font type.

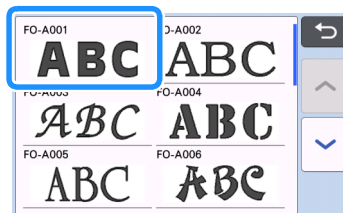

3 Type in the characters.

The keyboard is in the QWERTY layout. After entering the characters, touch the "OK" key.

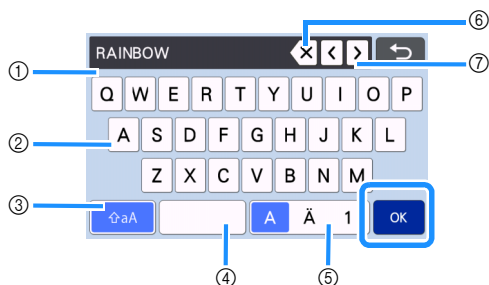

- ① Character input display
- ② Character keys
- ③ Uppercase/lowercase selection key
- ④ Space key
- ⑤ Letter/accented character/number selection key
- ⑥ Backspace key (deletes one character from the end of those displayed)
- ⑦ Cursor movement keys

Memo

- If the entered characters do not fit within the cutting/drawing area, the character size is automatically reduced.

4 Adjust the settings of character size and character spacing.

Touch or to adjust the character size or the space between characters. After completing the adjustment, touch the "Set" key.

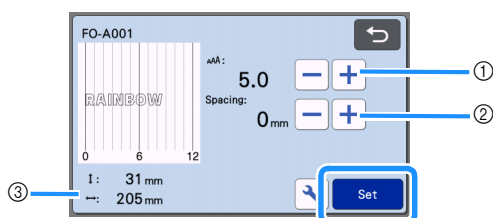

- ① Character size adjustment keys

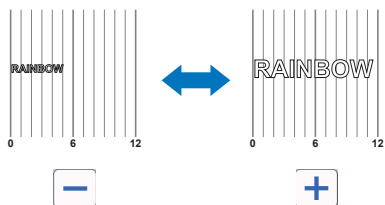

- ② Character spacing adjustment keys

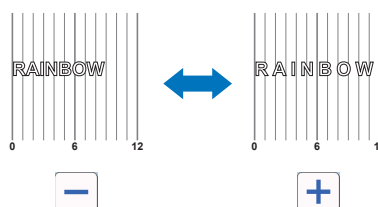

- ③ Size of entire character string

5 Check the character arrangement.

To cut or draw, touch the "OK" key.
To save the characters as data, touch the "Save" key.
For details on saving data, see "Saving" on page 53.

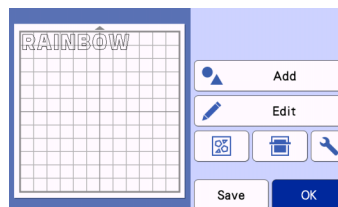

Memo

- Entered characters can only be edited as the entire character string. One character cannot be edited individually.

MEMORY FUNCTIONS

Patterns and characters arranged in the cutting/drawing area can be saved and recalled later.

- ❑ For details on the file formats that can be imported into the cutting machine from a USB flash drive or computer, see “Importing Designs” on page 57.
- ❑ If the name of the data file/folder cannot be identified, for example, when the name contains special characters, the file/folder is not displayed. If this occurs, change the name of the file/folder. We recommend using the 26 letters of the alphabet (uppercase and lowercase), the numbers 0 through 9, “-” and “_”.

Note

- USB flash drive is widely used, however some USB flash drive may not be usable with this machine. Please visit our website “<http://s.brother/cpoac/>” for more details.

Saving

Available in the following screen

Mat layout screen	→Tutorial 1; Step 5 (page 30) in “Selecting and Editing the Second Pattern”
--------------------------	---

- 1 Touch the “Save” key to display the file destination options.

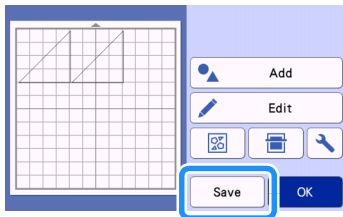

- 2 To save the data on a USB flash drive, insert the USB flash drive into the USB port (for a USB flash drive) on this machine.

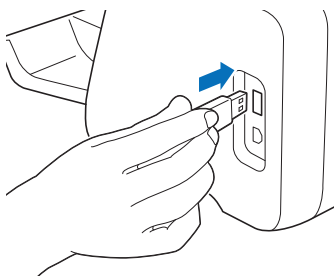

- 3 Touch the file location to save the file.

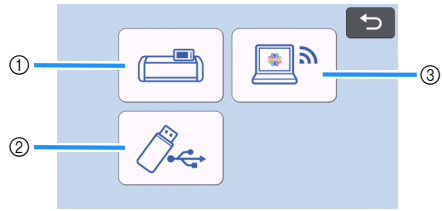

- 1 Save to the machine's memory.
 - ▶ When saving is finished, the following message and the name of the saved file appear.

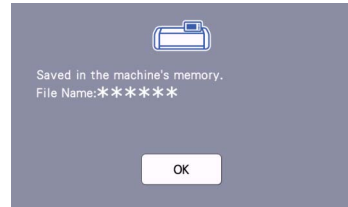

- 2 Save to the USB flash drive.
 - ▶ When saving is finished, the following message and the name of the saved file appear.



- The name of the saved file with the extension “.fcm” is automatically assigned.

Note

- While data is being saved, do not remove the USB flash drive.
- 3 Save to CanvasWorkspace.
 - In order to save to CanvasWorkspace, the machine must be connected to a wireless network. This is available only after a connection has been established with CanvasWorkspace. For details on making the connection, refer to “Wireless Network Setup Guide”.
 - This is a function for transferring data via a wireless network connection. For details, refer to “Transferring Data using the Wireless Network Connection Function” on page 5.
 - If in the home screen is blue, the machine is connected to a wireless network.

- ▶ When saving is finished, the following message appears. For details on checking data saved in CanvasWorkspace, refer to the Help for CanvasWorkspace.

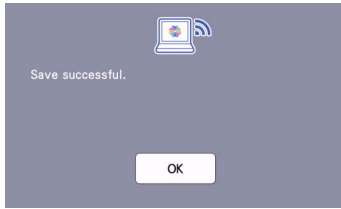

- 4 Touch the "OK" key to finish saving the data.

Retrieve Data

- 1 Touch the "Retrieve Data" key in the home screen to display the recall source selection screen.

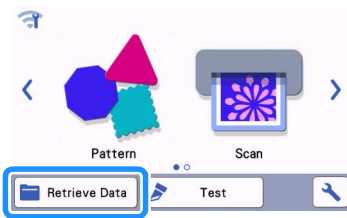

- 2 To use the data from a USB flash drive, insert the USB flash drive into the USB port (for a USB flash drive) on this machine.
- 3 Touch where you saved the pattern to be retrieved, and then select the pattern.



- 1 Retrieve from machine's memory key
- 2 Retrieve from USB flash drive key
- 3 Retrieve from CanvasWorkspace key (via a wireless network connection)
- 4 Retrieve from CanvasWorkspace key (using a USB cable)

- 1 Retrieve from the machine's memory.
- ▶ Touch the pattern to be retrieved and display.

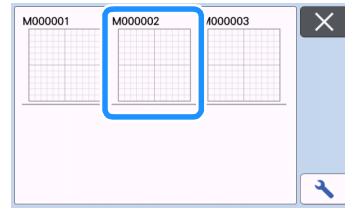

- 2 Retrieve from a USB flash drive.
- If there are folders on the USB flash drive, touch a folder to display the list of patterns that it contains.
 - If there are many folders or patterns, touch the arrows keys in the screen to scroll up or down.

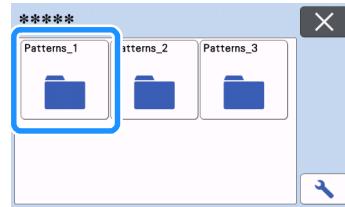

Memo

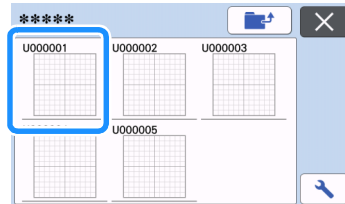

- It may take some time for the USB flash drive to be detected. Wait 5 to 6 seconds after inserting the USB flash drive before pressing a key. (The length of time differs depending on the USB flash drive.)
- When using a USB flash drive with an access indicator, wait until the indicator stops flashing.
- If an error is indicated, touch  again.

- ▶ Touch the pattern to be retrieved and display.



Memo

- When retrieving pattern data from the machine's memory or a USB flash drive, the size of the thumbnail previews can be changed.

Touch  to display the settings screen, and then touch  or  to change the size.

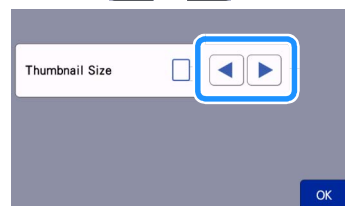

- ③ Retrieve from CanvasWorkspace (via a wireless network connection).
 - ▶ The transferred pattern from CanvasWorkspace appears on mat layout screen. For details, see “Retrieve from CanvasWorkspace (Via a Wireless Network Connection)” on page 55.
- ④ Retrieve from CanvasWorkspace (using a USB cable).
 - ▶ The transferred pattern from CanvasWorkspace appears on mat layout screen. For details, see “Retrieve from CanvasWorkspace (Using a USB Cable) (compatible only with Windows)” on page 56.

4 Check the preview of the pattern layout in the screen, and then touch the “OK” key.

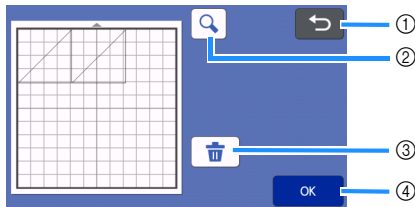

- ① **Returning Key**
Touch to return to the list of patterns at the destination.
- ② **Magnifying Key**
Touch to display the patterns in zoom mode.
- ③ **Deleting Key**
Touch to delete the data for the displayed pattern layout.
- ④ **OK Key**
Touch to recall the pattern layout data.

Memo

- Even if a seam allowance has been saved with the pattern(s) (see “Cutting Around Drawings” on page 63), the “Seam Allowance” setting specified in the settings screen will have priority and will be applied. If necessary, adjust the “Seam Allowance” setting in the settings screen (see “Seam Allowance” on page 11).

Retrieve from CanvasWorkspace (Via a Wireless Network Connection)

A pattern can be retrieved from CanvasWorkspace via a wireless network connection. For details, refer to “Transferring Data using the Wireless Network Connection Function” on page 5.

1 Register your machine under CanvasWorkspace.

- For details, refer to “Wireless Network Setup Guide”.

2 Start up CanvasWorkspace on a computer.

3 Click [Transfer FCM File via the Internet...] on the [File] menu to transfer an FCM file edited in CanvasWorkspace to the machine.

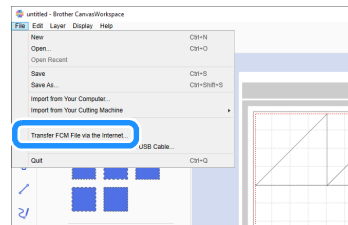

- For details on editing patterns in CanvasWorkspace, refer to the Help for CanvasWorkspace.
- ▶ When the pattern is transferred to the machine, the following message appears. Click [OK].



Note

- Only one pattern data can be transferred to the machine. If data had already been transferred to the machine, it will be overwritten.

Memo

- For CanvasWorkspace Internet version, click [Download] and then [ScanNCut Transfer] to send the FCM file to the machine.

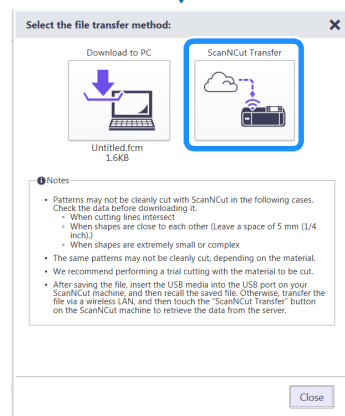
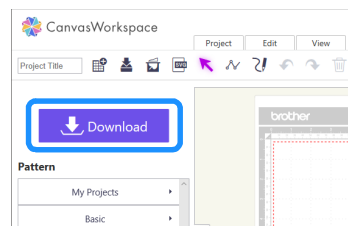

- 4 Touch the “Retrieve Data” key in the home screen to display the retrieve source selection screen.

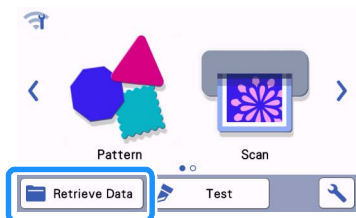

- If  in the home screen is blue, the machine is connected to a wireless network.

- 5 Select “Retrieve from CanvasWorkspace (via a wireless network connection)”.



- The mat layout screen appears.

Retrieve from CanvasWorkspace (Using a USB Cable) (compatible only with Windows)

When the machine is connected to the computer with a USB cable, a pattern can be retrieved from CanvasWorkspace (PC version).

■ Connecting Your Machine to the Computer

- Compatible models:
IBM PC with a USB port as standard equipment
IBM PC-compatible computer equipped with a USB port as standard equipment
- Compatible operating systems:
Microsoft Windows 7 SP1, Windows 8.1, Windows 10 (except Windows 10 S mode)

■ USB Cable (Sold Separately)

- We recommend using a USB 2.0 cable (Type A/B) that is no longer than 2 meters (6 feet).

■ Transferable File Formats

- FCM files opened in CanvasWorkspace

- 1 Insert the USB cable connector into the corresponding USB ports for the computer and for the machine.

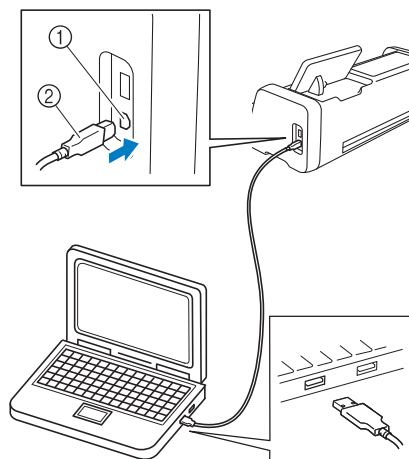

- ① USB port for computer
- ② USB cable connector

Note

- The connectors on the USB cable can only be inserted into a port in one direction. If it is difficult to insert the connector, do not insert it with force. Check the orientation of the connector.

- 2 Start up CanvasWorkspace on a computer.
- 3 Click [Transfer FCM File to ScanNCut DX via USB Cable...] on the [File] menu to transfer the FCM file edited in CanvasWorkspace to the machine.

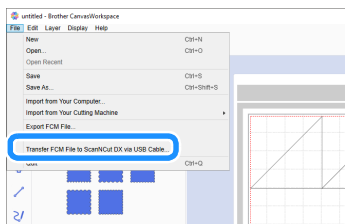

- When the pattern data is saved to the machine, the following message appears. Click [OK].

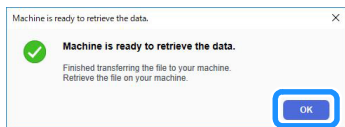

Note

- Only one pattern data can be transferred to the machine. If data had already been transferred to the machine, it will be overwritten.

- 4 Touch the “Retrieve Data” key to display the recall source selection screen.

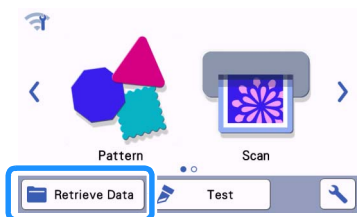

- 5 Select “Retrieve from CanvasWorkspace (using a USB cable)”.



- The mat layout screen appears.

Importing Designs

■ Importable File Formats

In addition to the FCM format, files in the following formats can be imported into the machine.

- Embroidery data in PHC/PES format (compatible models and via USB flash drive only): For details, see page 58.
- SVG (Scalable Vector Graphics: vector image format for describing two-dimensional graphics) format. “.svg” data is displayed in the pattern list screen by file name (the actual image cannot be displayed).

Memo

- The imported vector graphics will appear in the edit screen after they have been converted. This feature allows you to import only vector data. Image, text, width of the line, gradient, opacity, and any other styles or attributes of line will not be imported.

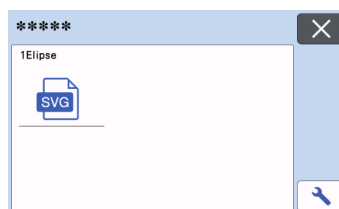

Retrieving Embroidery Data for Cutting (Compatible Models Only)

Embroidery data (.phc or .pes files) can be retrieved to the machine, then cut out or drawn. .phc files are embroidery data from sewing machines equipped with an embroidering function, and .pes files are embroidery data created with the embroidery design software system PE-DESIGN. With this embroidery data, outline data or region data of parts of each color or of the entire pattern can be created.

Memo

- This feature is compatible only with models equipped with a function to import embroidery data. For the functions available with your machine model, check “Embroidery Data (.PES/.PHC)” under “Machine Information” of the settings screen.

Note

- For details on .phc and .pes files, contact your authorized Brother dealer or the nearest Brother authorized service center.

Note

- .phc and .pes files cannot be imported into CanvasWorkspace. Retrieve the patterns directly from a USB flash drive to the cutting machine.

► A confirmation screen appears.

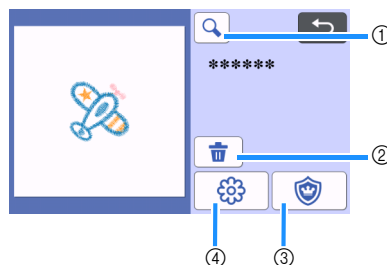

- ① Magnifying
Zoom in on the pattern to 200%. Then, touch  to display the patterns enlarged by 400%. To scroll through the screen, touch the arrow keys.
- ② Deleting
Delete the selected patterns.
- ③ Appliqué
Create cutting data for an appliqué piece.
- ④ Embroidering lines
Convert embroidery data to cutting/drawing data.

Note

- With embroidery data created from a photo, intricate shapes are not suitable for cutting. Use the Enhanced Image Tracing function (premium function) of CanvasWorkspace to extract the necessary outlines from the original photo.

Preparing .phc or .pes Files

■ .phc Files

Using a sewing machine that can save embroidery patterns to an external device, save the embroidery pattern to the USB flash drive. The procedure for saving the embroidery pattern to the USB flash drive differs depending on the sewing machine. Refer to the operation manual for your sewing machine.

■ .pes Files

Using embroidery design software system, save the embroidery pattern to the USB flash drive. The procedure for saving the embroidery pattern to the USB flash drive differs depending on the version of the software. Refer to the instruction manual for your software. This manual uses embroidery patterns created with PE-DESIGN as examples.

Retrieving the Pattern to the Cutting Machine

- ① Retrieve the embroidery pattern (.phc or .pes file) from the USB flash drive to the machine. (Refer to “Retrieve Data” on page 54.)



Creating Appliqué Data

Memo

- Make sure that the pattern contains an “APPLIQUE MATERIAL” pattern.

- 1 Touch  to display the pattern piece list screen, and then touch the “OK” key.

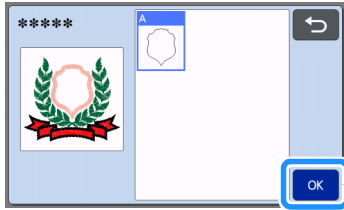

▶ The pattern editing screen appears.

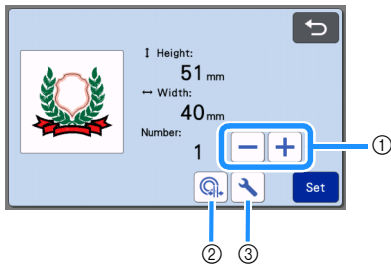

- 1 Duplicating
Create a duplicate of the pattern. For details, see “Pattern Editing Functions” on page 40.
- 2 Outline Distance
Specify the distance from the outline of the pattern to the cutting line. For details, see “Advanced Cutting Functions for “Direct Cut”” on page 73.
- 3 Settings
Specify the measurement units (millimeters or inches), cutting area and pattern spacing. For details, see “Settings Screen” on page 10.

- 2 Touch the “Set” key to display the mat layout screen.

- The pattern can be edited. For details, see “Mat Layout Screen” on page 41 or “Layout Editing Functions” on page 42.

- 3 Touch the “OK” key.

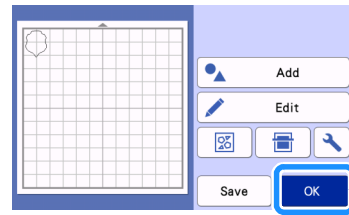

▶ “APPLIQUE MATERIAL” appears in the screen.

- 4 Attach the fabric for the appliqué piece to the mat, and then cut out the pattern.
- 5 Refer to the operation manual for the sewing machine to complete the appliqué.

Creating Embroidering Line Data

- 1 Touch  to display the pattern editing screen, and then touch the “OK” key.

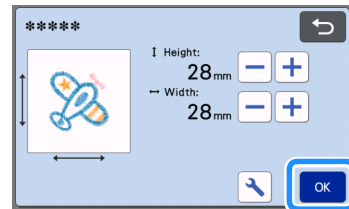

- The pattern size can be adjusted in this screen. For details, see “Pattern Editing Functions” on page 40.

- 2 In the part selection screen, select the color recognition mode.

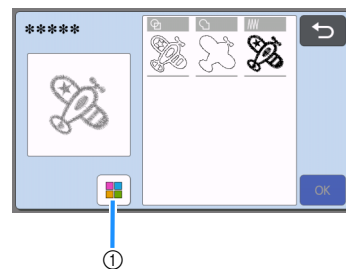

① Switch on and off color recognition mode.

- Color recognition mode switched off
The cutting/drawing data is created after the embroidery pattern is converted to grayscale.

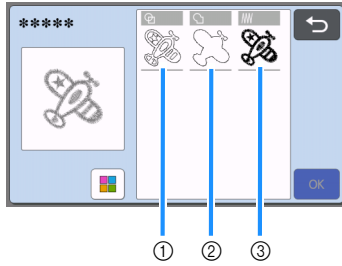

- ① Region detection
Select this option to detect the colored portions of a pattern as regions and create a cutting/drawing lines around each region.
- ② Outline detection
Select this option to convert the outline of the image to cutting/drawing lines.
- ③ Stitching line detection
Select this option to convert the stitching lines embroidered by the machine to cutting/drawing lines.
Stitching line detection is not suitable for cutting since the needle movements of the sewing machine are faithfully converted to data. We recommend using this option for drawing and line embossing (premium function).

Differences in cutting/drawing lines depending on detection method (color recognition mode switched off)

	: Region detection	: Outline detection	: Stitching line detection
Original image			
Cutting/drawing lines			
Finished project after cutting/drawing			

- Color recognition mode switched on
Each color in the embroidery pattern is detected to create cutting data.

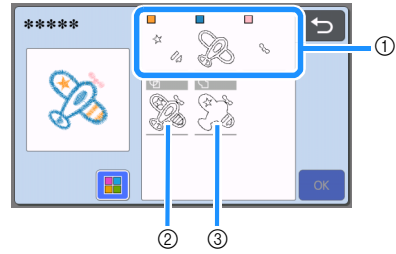

- ① The parts for each color detected as a region are displayed in the list.
- ② Region detection
- ③ Outline detection

Differences in cutting/drawing lines depending on detection method (color recognition mode switched on)

	: Region detection	: Outline detection
Original image		
Cutting/drawing lines		
Finished project after cutting/drawing		

- ③ Select the detection method, and then touch the "OK" key.

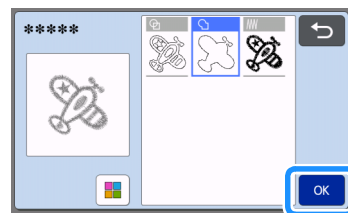

4 Adjust the cutting/drawing lines.

After making the desired adjustments, touch the “Set” key.

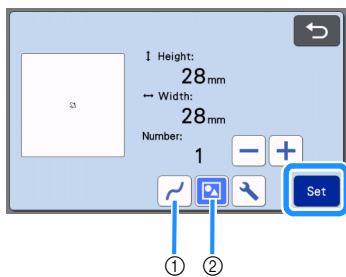

- ① Smoothing
Smooths out curves and corners in the lines. Select from the four settings available: OFF, Low, Middle and High.

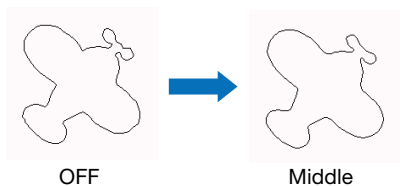

- ② Grouping/Ungrouping
When ungrouped, the parts can be edited separately. For details, see “Grouping/Ungrouping Patterns” on page 44. The setting cannot be changed if there is only one shape.

Memo

- If the pattern contains unnecessary parts, ungroup it. This allows the unnecessary parts to easily be deleted in the mat layout screen, which appears next.

5 In the mat layout screen, check the cutting/drawing lines.

- The pattern can be edited. For details, see “Mat Layout Screen” on page 41 or “Layout Editing Functions” on page 42. After finishing all editing, touch the “OK” key.

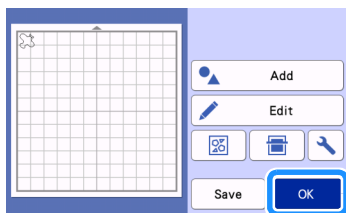

DRAWING FUNCTIONS

With a pen and pen holder, you can draw patterns on material. Using the seam allowance settings also allows you to draw patterns with seam allowances on material and then cut them out. These drawing functions can be used to create quilt pieces.

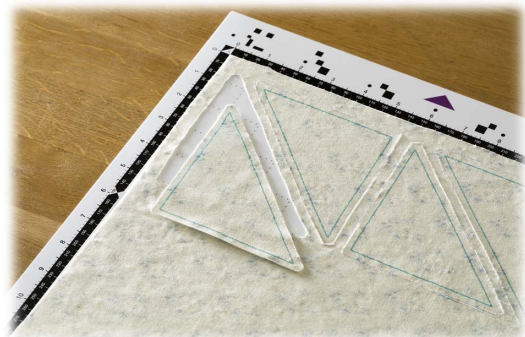

■ Preparation

Prepare the following accessories for drawing. An additional purchase may be required depending on the machine model.

- Pen holder
- Erasable pen set or color pen set
- Mat appropriate for the material that will be drawn on.
- Blade and blade holder appropriate for the material that will be cut.
- Iron-on fabric appliqué contact sheet or high tack adhesive fabric support sheet appropriate for fabrics that will be cut or drawn on.

Drawing

In this example, we will draw a built-in pattern on material.

■ Preparing the Pen Holder

- 1 Press the button at the center of the pen holder to unhook the lid and open it.

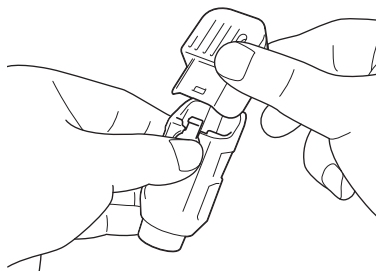

- 2 Remove the cap from the pen, and then insert the pen into the pen holder with the point down.

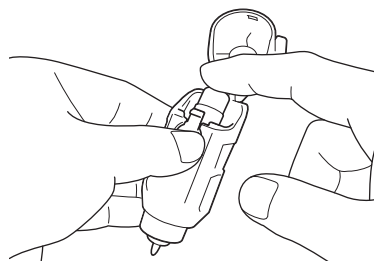

- 3 Close the lid of the pen holder.



- After use, remove the pen from the pen holder, and then attach the cap to the pen before storing it.

■ Drawing

- 1 Grasp the holder grip, and then install the pen holder in the carriage with its lid opening button facing against you.

- For details, see “Installing and Uninstalling the Holder” on page 24.

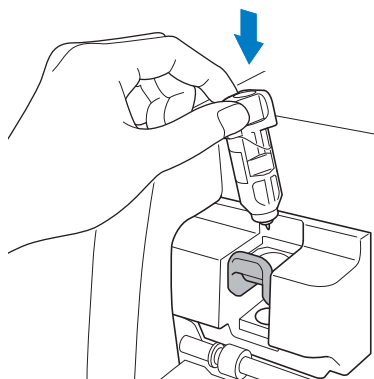

- 2 Select and edit the pattern.

- For details on selecting and editing patterns, see “Selecting and Editing the First Pattern” on page 29.

- 3** Raise the scanner lever (on the left side of the machine) to “2”.

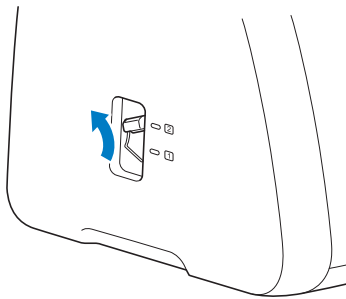

- 4** Load the mat with the material for drawing (cutting) attached.

- Lightly insert the mat into the feed slot, and press  in the operation panel.
- For details on inserting the mat, see “Loading the Mat” on page 26.

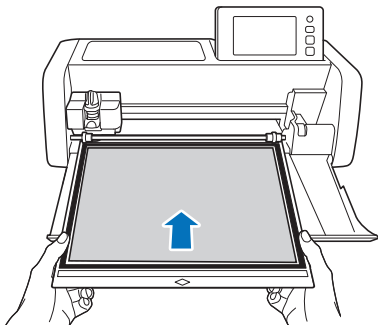

- 5** Select “Draw” in the preview screen.

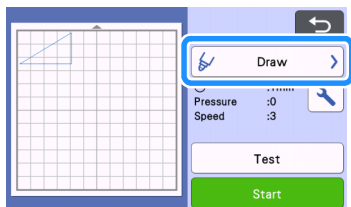

- ▶ The drawing line (blue) appears.

- 6** Adjust the drawing speed and pressure.

Before drawing the pattern, adjust the drawing speed and pressure. These adjustments can be made from the settings screen. Touch .

- ▶ Touch  or  to change the settings.

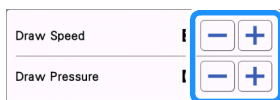

Note

- If the drawing pressure is too high, the pen tip may be damaged. Adjust it to an appropriate setting.

Memo

- Adjustments to the drawing pressure will affect the finished product. Use the same material that the pattern will be drawn on to make the adjustments.

- 7** Touch the “Start” key to start drawing.

Note

- After use, remove the pen from the pen holder, and then attach the cap to the pen before storing it.

Cutting Around Drawings

In this example, we will specify a seam allowance for a built-in pattern and draw the pattern, then cut an outline around it.

■ Specifying the Seam Allowance

- 1** Select the pattern to be drawn, and then touch the “Set” key.

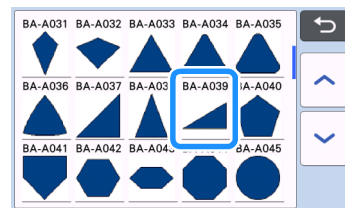

- ▶ The mat layout screen appears.

- 2** Touch the “Edit” key.

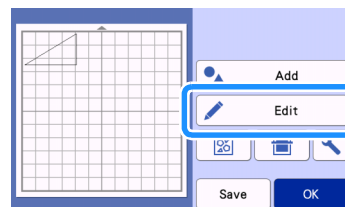

- 3 Touch the “Object Edit” key in the object editing screen.

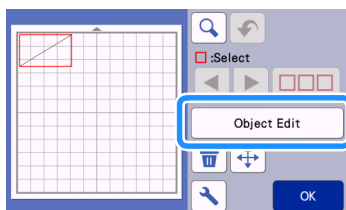

- 4 Touch .

The Seam Allowance screen appears. If  appears in gray, the seam allowance cannot be applied.

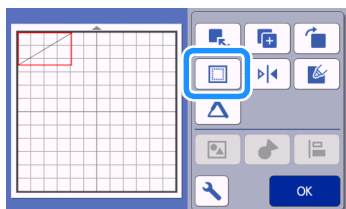



Memo

- Depending on the pattern, the seam allowance may be applied as a default. Check the setting.
- ▶ The pattern in the preview appears with a drawing line (blue) and a cutting line (black).

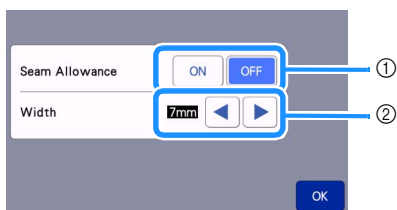
- 5 Specify the seam allowance settings.



- Select whether or not to add a seam allowance.
- Specify the width (distance between the outline and cutting line) of the seam allowance. Touch  or  to change setting.

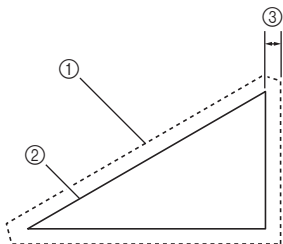

- Seam allowance line
 - Pattern outline (stitching line)
 - Seam allowance
- ▶ Touch the “OK” key to finish specifying the setting and return to the mat editing screen.

- 6 Touch the “OK” key in the object editing screen, and then touch the “OK” key.

- 7 Touch the “OK” key to finish editing the pattern.

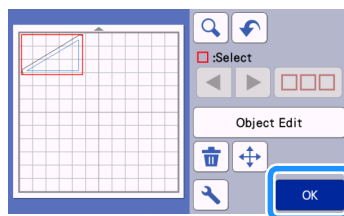

Memo

- To draw the seam allowance on the wrong side of the fabric, flip the pattern.

Image of Pattern Piece to be Created

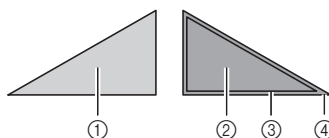

- Right side of fabric
- Wrong side of fabric
- Drawing line (stitching line)
- Seam allowance line

- ▶ After attaching to the mat the fabric with the wrong side facing up, load the mat into the machine, flip the pattern, and then draw it and cut it out.

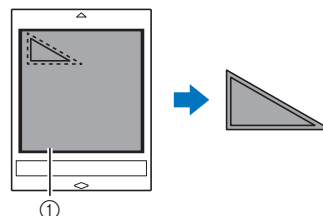

- Wrong side of fabric

B Check the pattern arrangement, and then touch the "OK" key.

When using fabric, the patterns may not be cleanly cut if they are arranged near the edge of the fabric. In this case, move patterns so they are at least 10 mm from the fabric edge (the edge of the cutting/drawing area in the screen).

- To re-edit the pattern arrangement after checking it, touch the "Edit" key. For details, see "Mat Layout Screen" on page 41.
- Select the "Cut Area" setting appropriate for the mat being used. (See page 10.)

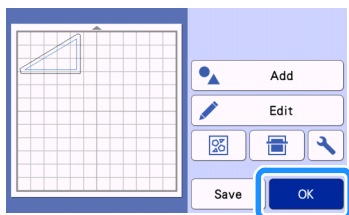

▶ The preview screen appears.

■ Loading the Material

Load the mat with the material for cutting (drawing) attached.

When drawing the seam allowance on the wrong side of the fabric, attach the material to the mat with its wrong side facing up.

- For details on attaching material to the mat, see "Reference Table of Mat and Material Combinations" on page 14.
- Lightly insert the mat into the feed slot, and press  in the operation panel.
- For details on inserting the mat, see "Loading the Mat" on page 26.

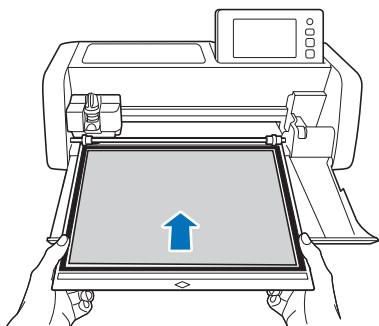

■ Drawing

1 Select "Draw" in the preview screen.

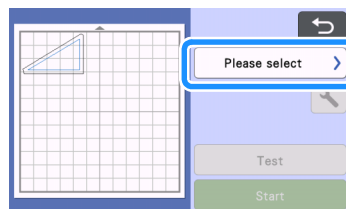

▶ A preview of the line to be drawn appears.

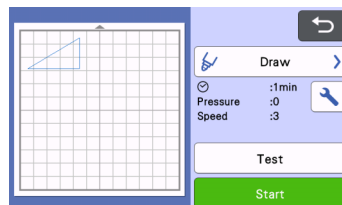

2 Adjust the pen pressure.

For details on adjusting the drawing pressure, see step **B** (page 63) in "Drawing".

3 Touch the "Start" key to start drawing.

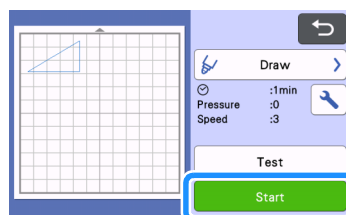

▶ When drawing is finished, the message appears in the screen. After you touch the "OK" key, the preview screen appears.

- To perform test/trial drawing operations to adjust the drawing pressure, touch the "Test" key. For details, see "Test Cut (Trial Cut)" on page 25.
- To cut around the drawn patterns, keep the mat inserted into the slot without pressing , and continue with the following cutting procedure.

■ Cutting

- 1 Select "Cut" in the preview screen.

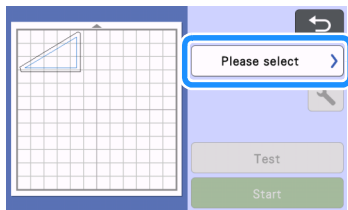

▶ A preview of the line to be cut appears.

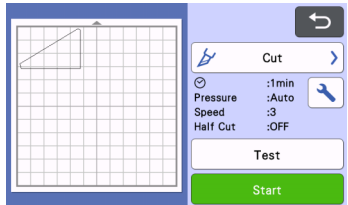

- 2 Remove the pen holder, and then install the blade holder.

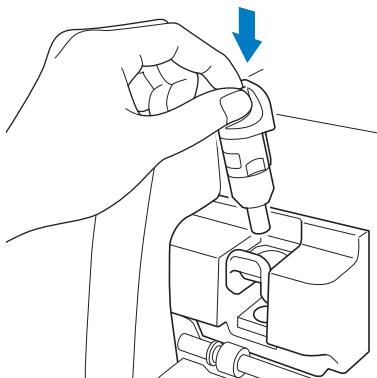

Note

- After use, remove the pen from the pen holder, and then attach the cap to the pen before storing it.

! WARNING

- This is not a toy and is not intended to be used by children. In order to prevent choking hazards, do not allow infants/children to put the protective caps in their mouths.

! CAUTION

- Please remove protective cap from blade holder before placing it into the machine carriage.

- 3 Touch the "Start" key to start cutting.

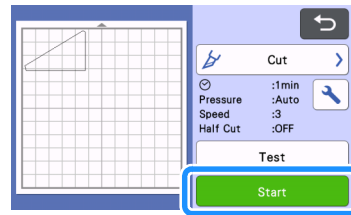

▶ When cutting is finished, the preview screen appears.

- 4 Press  in the operation panel to feed out the mat.

- 5 Peel the patterns off the mat.

- For details, see "Unloading the Mat" on page 27.

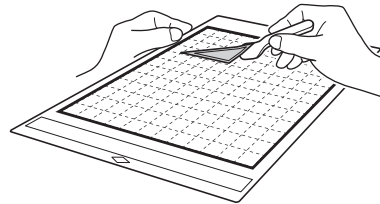

Using Drawing Functions to Fill Patterns/Make Outlines Thicker

❏ Precautions for Using the Fill Function

- Depending on the material and pen being used, material drawn with a filled pattern may be difficult to peel off or may tear. Perform test/trial drawing with the pattern to be used in your project.
- An open pattern cannot be filled.
Example:



- When fill settings are specified, the settings are applied to all patterns in the pattern layout screen.
- Fill and additional line settings cannot both be specified for the same pattern.

■ Filling Patterns

- 1 Touch  in the object editing screen.

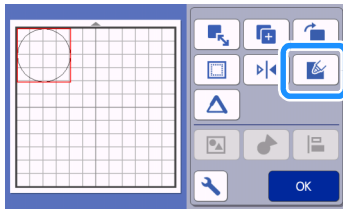

Settings screen



- 1 **Fill**
Select whether or not to fill patterns.

② Fill Pattern

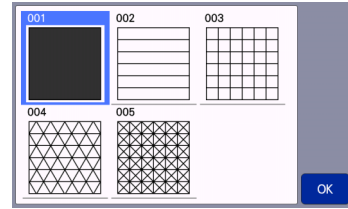

③ Fill Line Spacing

Adjust the spacing of the lines filling the pattern.

④ Fill Direction

Adjust the direction of the fill pattern.

■ Making Pattern Outlines Thicker

Additional lines can be drawn to make pattern outlines appear thicker.

- 1 Touch  in the object editing screen to display the outline settings screen.

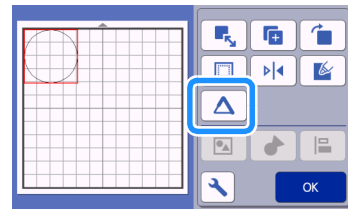

Settings screen



Note

- The settings for “Number of Additional Line” and “Additional Line Spacing” will not be applied to patterns with fill settings applied. For details on the fill settings, see “Using Drawing Functions to Fill Patterns/Make Outlines Thicker” on page 67.

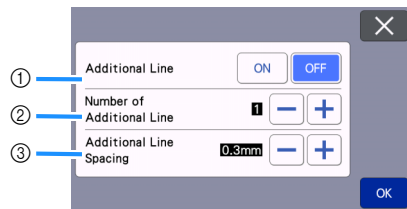

- 1 **Additional Line**
Select whether or not lines are to be added.
- 2 **Number of Additional Line**
Specify the number of lines to be added.

③ Additional Line Spacing

Specify the spacing of the lines to be added.



Note

- Refer to the following examples when specifying settings for “Number of Additional Line” and “Additional Line Spacing”.

① Number of Additional Line 1: One line added.

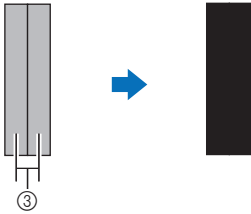

② Number of Additional Line 2: Two lines added.

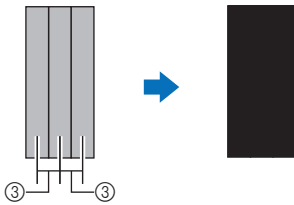

- #### ③ Additional Line Spacing: Adjusts the line spacing. Increasing the line spacing creates a space between the lines.



Memo

- The drawing result differs depending on the thickness of the pen that is used. Make adjustments according to the pen thickness.

Chapter 4 SCANNING FUNCTIONS

SCANNING FOR CUTTING (Direct Cut)

A printed image (paper/sticker), stamped paper or an original hand-drawn illustration can be scanned and its outline can be cut out or drawn. This is useful for scanning images for paper crafts, then cutting them out.



Tutorial 3 - Scanning and Cutting

In this tutorial, we will scan an illustration drawn on paper, then cut around it.

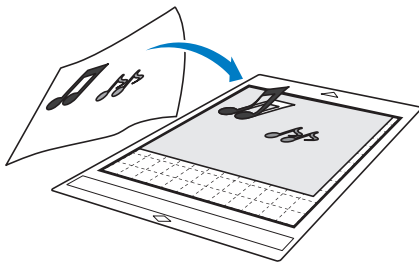

Preparation

- 1 Prepare the original.

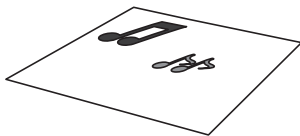

When using the "Direct Cut" mode, use originals like those described below.

- Patterns that are clearly drawn, with no gradation, fading or blurriness
- Not using an extremely intricate design



- 2 Press to turn on the machine.
 - For details, see "Turning On/Off the Machine" on page 8.
- 3 Install the cutting blade holder into the carriage of the machine.
 - For details, see "Installing and Uninstalling the Holder" on page 24.

Scanning

Depending on the color of the illustration, it can be scanned in grayscale or color recognition mode.

- 1 Touch the "Scan" key in the home screen to select the scanning mode.

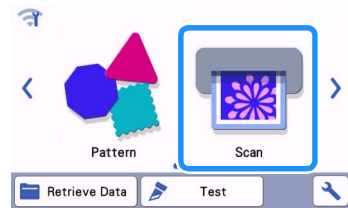

- 2 Select "Direct Cut" in the scanning mode selection screen.

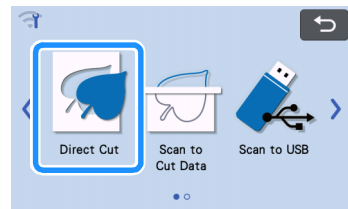

▶ A message appears.

- 3 In the selection screen for the cutting data destination, touch .



4 Select the scanning mode according to the material to be scanned.

- First, test with grayscale recognition mode. If the desired cutting data is not created, test with color recognition mode.

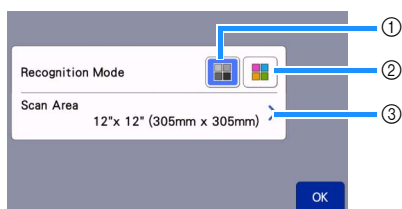
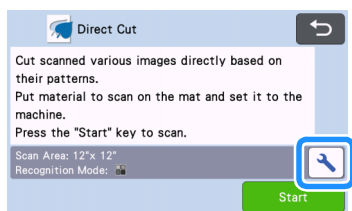





① Grayscale recognition mode

The cutting data is created after the illustration is converted to grayscale.

Scanning in grayscale recognition mode is most appropriate for illustrations with clear outlines or distinct brightness differences. Processing is faster with this mode compared with the color recognition mode.

If there are adjacent objects of the same color after an illustration has been converted to grayscale, select the color recognition mode.

Examples of illustrations appropriate for grayscale recognition mode:

Example	Result
Outlines that are clear 	
Distinct difference in brightness between background and illustration 	

Memo

- The edges of illustrations in a color of the same brightness as their background, as shown below, cannot be detected. In this case, use the color recognition mode.







- ① Background and illustration in colors with the same brightness.

② Color recognition mode

The cutting data is created without converting the illustration to grayscale. Creating data in this mode may take longer, depending on the pattern.

- * The default scanning recognition setting is the grayscale recognition mode.

Examples of illustrations appropriate for color recognition mode:

Example	Result
Illustrations that are the same light color as the background 	
Illustrations that are the same dark color as the background 	

③ Scanning area

The scanning size settings screen appears. The size of the scanning area can be selected. The available scanning area sizes differ depending on the model.

- 5** Attach the original that will be scanned to the mat.

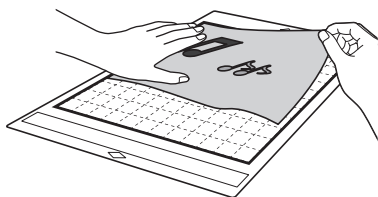

Memo

- In "Direct Cut" mode, the scanning mat cannot be used.
- Depending on the machine model, the sizes of mats that can be used will differ. Check the "Maximum Scanning Area" under "Machine Information" of the settings screen.
- Before attaching the material to the mat, use a corner of the adhesive side of the mat to test attaching it.

- 6** While holding the mat level and lightly inserting it under the feed rollers on the left and right sides of the feed slot, press  in the operation panel.

- For details, see "Loading the Mat" on page 26.

- 7** Touch the "Start" key to start scanning.

Note

- When the scanner lever is raised, the following message appears.

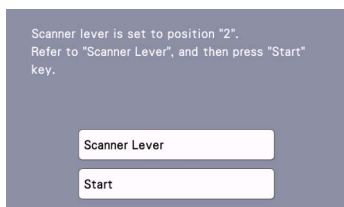

Scanning with the lever raised may result in blurry scans.

■ Creating Cutting Data

The procedure for creating cutting data differs depending on the mode.

□ Grayscale recognition mode

- 1** Check the scanned image, and then touch the "OK" key.

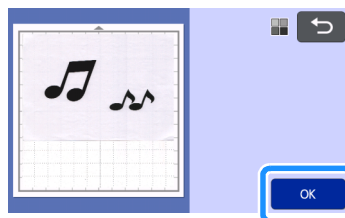

- 2** In the image trim screen, use the touch pen to drag  to trim the image to the size to be imported.

- When trimming is performed, the "OK" key changes to the "Preview" key.
- ▶ If cutting lines are created, the outline of the scanned illustration will be black.

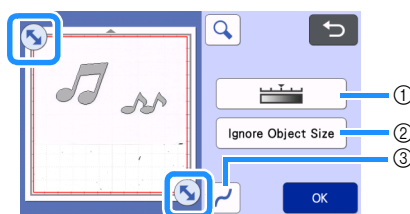

- Image Detection Level Key**
Adjust the image detection level.
- Ignore Object Size Key**
Small unnecessary patterns (dotted lines, etc.) can be excluded from cutting data. For details, see "Specifying "Ignore Object Size"" on page 81.
- Smoothing Setting Key**
Specify the level of smoothing applied to the image outline. For details, see "Adjusting Image Detection Levels" on page 81.

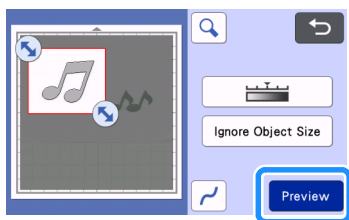

- 3 Touch the "Preview" key to confirm the trimmed area.

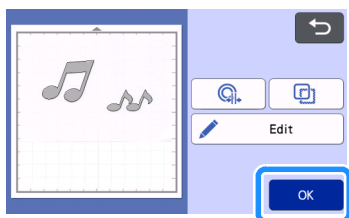

▶ Only the cutting lines appear.

- 4 Touch the "OK" key in the mat layout screen.



- Touch the "Edit" key to fill patterns or make outlines thicker. For details, see "Using Drawing Functions to Fill Patterns/Make Outlines Thicker" on page 67. In addition, a pattern can be deleted, or multiple patterns can be selected. For details on selecting multiple patterns, see "Selecting Multiple Patterns" on page 38.
- Touch  or  to edit the imported cutting data. For details, see "Advanced Cutting Functions for "Direct Cut"" on page 73.

- 5 Select "Cut" in the preview screen.

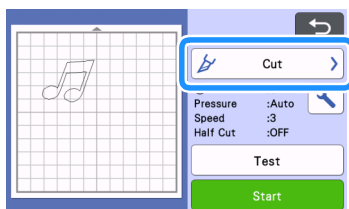

- 6 Touch the "Start" key to start cutting.

- For details on unloading the mat after cutting, follow the procedure under "Unloading the Mat" on page 27.

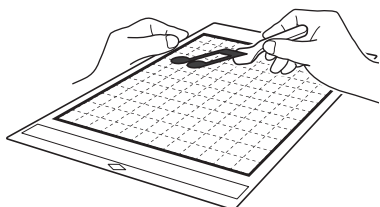

Color recognition mode

- 1 In the image trim screen, use the touch pen to drag  to trim the image to the size to be imported, and then touch the "OK" key.

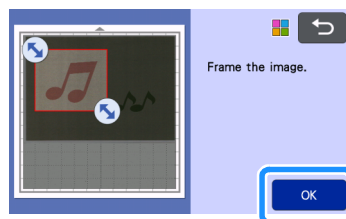

Memo

- Trimming the image to the desired size can reduce the amount of time required to convert it to cutting data.

- 2 Check the imported image in the image editing screen.

▶ The created cutting data appears as black lines.



① Image Detection Level Key

If the cutting lines were not correctly detected, change the number of colors to be detected. If a color that appears as a single color is detected as separate colors, reduce the number of colors. If adjacent colors with a similar brightness are detected as a single color, increase the number of colors.



original

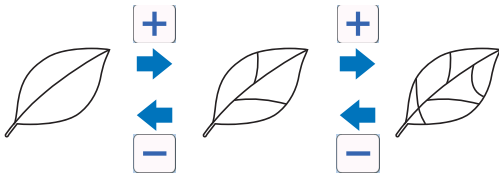

2 Ignore Object Size Key

Small unnecessary patterns (dotted lines, etc.) can be excluded from cutting data. For details, see “Specifying “Ignore Object Size”” on page 81.

3 Smoothing Setting Key

Specify the level of smoothing applied to the image outline. For details, see “Adjusting Image Detection Levels” on page 81.

4 OK Key

Touch the “OK” key to apply the settings. When trimming is performed, the “OK” key changes to the “Preview” key. After trimming, touch the “Preview” key to check the trimming results.

Memo

- When making a stamp, for example, the image may not be converted to cutting data if it contains a gradation or areas that are only partially filled with a color.

3 Touch the “OK” key.

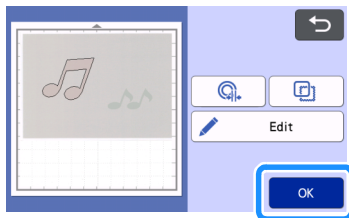

- Touch or to edit the imported cutting data. For details, see “Advanced Cutting Functions for “Direct Cut”” on page 73.
- Touch the “Edit” key to fill patterns or make outlines thicker. For details, see “Using Drawing Functions to Fill Patterns/Make Outlines Thicker” on page 67. In addition, a pattern can be deleted, or multiple patterns can be selected. For details on selecting multiple patterns, see “Selecting Multiple Patterns” on page 38.
- ▶ Only the cutting lines appear.

4 Select “Cut” in the preview screen.

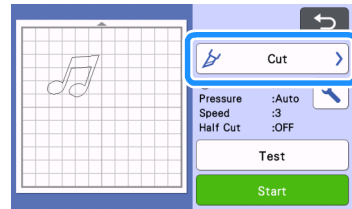

5 Touch the “Start” key to start cutting.

- For details on unloading the mat after cutting, follow the procedure under “Unloading the Mat” on page 27.

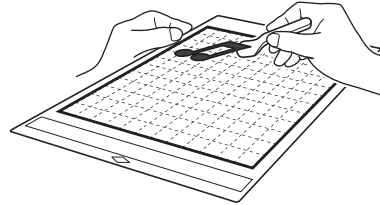

Advanced Cutting Functions for “Direct Cut”

■ Outline Distance

Use this function to cut while adding a margin around patterns. Specify the distance from the cutting line to the outline of the scanned image.

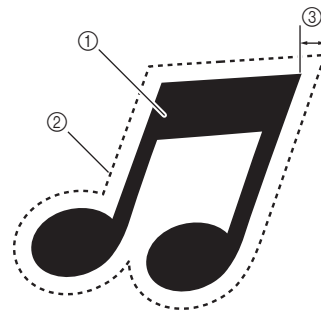

- ① Pattern outline
- ② Cutting line
- ③ Outline distance

Available in the following screen

Image trim screen	→Tutorial 3; Step ③ (page 72) in “Grayscale recognition mode” or Step ③ (page 73) in “Color recognition mode”
--------------------------	---

1 Touch .

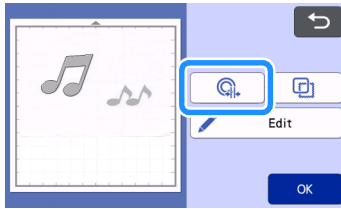

► The setting screen appears.

2 Touch  or  to change the setting.

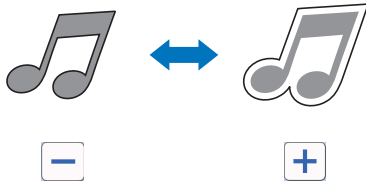
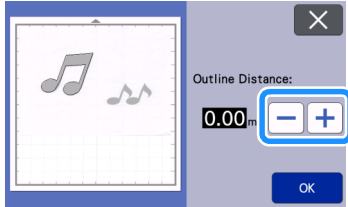

■ Outlining and Framing

Any shape can be specified as the cutting line for the scanned image.

Available in the following screen

Image trim screen	→Tutorial 3; Step 3 (page 72) in "Grayscale recognition mode" or Step 3 (page 73) in "Color recognition mode"
-------------------	---

1 Touch .

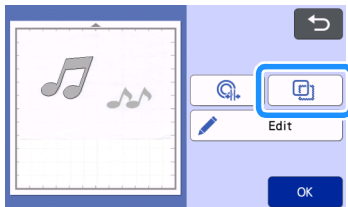

► The settings screen appears.

2 Select the shape of the cutting line.

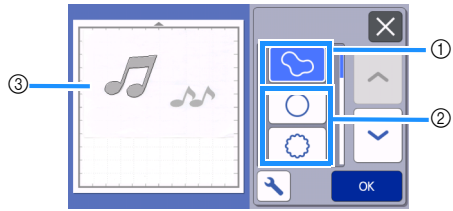

① **Outlining**

Touch this key to create a cutting line that follows the outline of the scanned image.

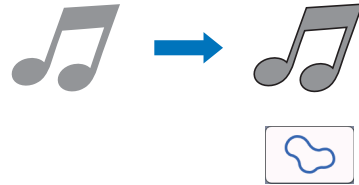

② **Framing**

Touch the key for the desired frame to add it to the scanned image and create a cutting line that follows its shape.

- If there are multiple images, a frame can be specified for each image.

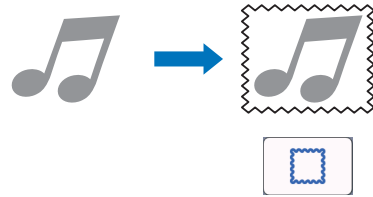

③ **Previewing**

Display a preview of the image together with the cutting line for the selected frame.

CREATING CUTTING DATA (Scan to Cut Data)

A printed pattern or image or an original hand-drawn illustration can be scanned, converted to cutting lines for cutting/drawing with this machine, then saved as data.



Tutorial 4 - Creating Cutting Data

In this tutorial, we will save an illustration drawn on paper as cutting data.

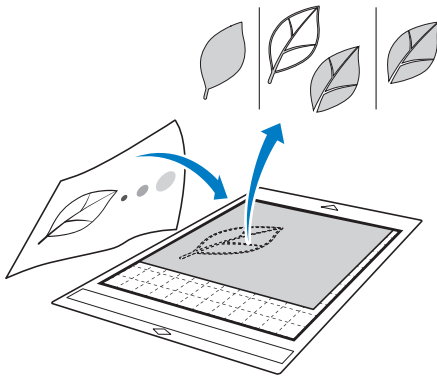

■ Preparing the material

When using the “Scan to Cut Data” mode, use originals like those described below.

- Patterns that are clearly drawn, with no gradation, fading or blurriness
- Not using an extremely intricate design



■ Scanning

- 1 Touch the “Scan” key in the home screen to select the scanning mode.

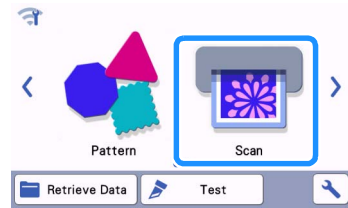

- 2 Select “Scan to Cut Data” in the scanning mode selection screen.

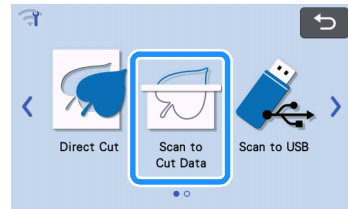

▶ A message appears.

- 3 Touch , select the scanning mode, and then touch the “OK” key.

- First, test with grayscale recognition mode. If the desired cutting data is not created, test with color recognition mode.

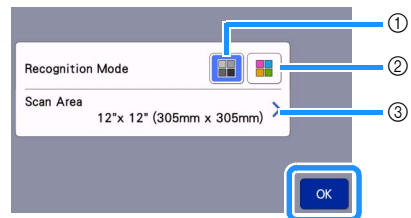
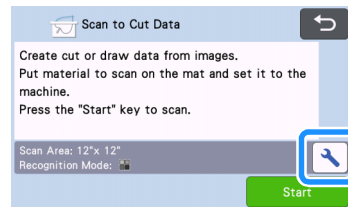

- 1 **Grayscale recognition mode**

The cutting data is created after the illustration is converted to grayscale. Scanning in grayscale recognition mode is most appropriate for illustrations with clear outlines or distinct brightness differences. Processing is faster with this mode compared with the color recognition mode.

If there are adjacent objects of the same color after an illustration has been converted to grayscale, select the color recognition mode.





② Color recognition mode

The cutting data is created without converting the illustration to grayscale.

Creating data in this mode may take some time.

* The default color recognition setting is the grayscale recognition mode.

Examples of illustrations appropriate for recognition mode:

Example		Recommended recognition mode
Outlines that are clear		Grayscale recognition mode
		
<ul style="list-style-type: none"> • Distinct difference in brightness between background and illustration • Different brightness of adjacent colors 		Color recognition mode
<ul style="list-style-type: none"> • Similar brightness of adjacent colors 		

Memo

- The edges of adjacent colors with the same brightness, as shown below, cannot be detected. In this case, use the color recognition mode.

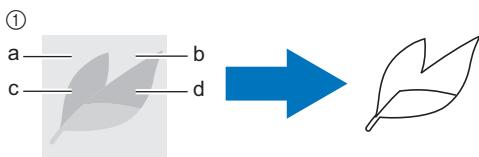

- ① "a" and "b" as well as "c" and "d" have the same brightness.

③ Scanning area

The scanning size settings screen appears. The size of the scanning area can be selected. The available scanning area sizes differ depending on the model.

④ Attach the original to the mat, and then load the mat into the feed slot.

- Lightly insert the mat into the feed slot, and press in  the operation panel.
- For details on loading the mat, see "Loading the Mat" on page 26.

Memo

- Depending on the machine model, the sizes of mats that can be used will differ. Check the "Maximum Scanning Area" under "Machine Information" of the settings screen.

⑤ Touch the "Start" key to start scanning.

- When the scanner lever is raised, a confirmation message appears. For details, see step ⑦ in "Scanning" of "Tutorial 3 - Scanning and Cutting" on page 69.
 - ▶ When scanning is finished, the scanned image appears in the screen.

■ Creating Cutting Data

The procedure for creating cutting data differs depending on the mode.

□ Grayscale recognition mode

1 Select the cutting line type in the image editing screen.

The image shape is detected and cutting lines are created based on one of three standards. For this example, touch  to create cutting lines using region detection.

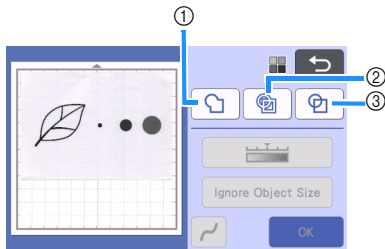

① Outline detection

If you wish to cut/draw along the outline of an image, select this option to convert the outline of the image to a cutting line. This is useful for saving as data an illustration drawn for an appliqué.

② Region detection

Select this option to detect the colored portions of an image as regions and create a cutting line around each region. Cutouts can be created using thick hand-drawn lines, such as borderlines of images or text illustrations. This option allows you to use not only cut-out patterns but the material from which portions are cut out, such as lace.

③ Line detection (Grayscale recognition mode only)

Select this option to detect the center of lines and convert them to a cutting line. This is useful for detecting patterns consisting of multiple pieces and creating cutting lines for each piece.

Memo

- Lines thicker than 1.5 mm will not be detected as lines.

Difference in cutting lines depending on detection standard

Example 1

	① Outline detection	② Region detection	③ Line detection
Original			
Cutting lines			
Finished project after cutting			

Example 2

	① Outline detection	② Region detection	③ Line detection
Original			
Cutting lines			Does not apply since there are no outlines for each color in the original.
Finished project after cutting			

2 Use the touch pen (stylus) to touch  and drag it around the screen to trim the cutting lines.

- When trimming is performed, the “OK” key changes to the “Preview” key. Touch the “Preview” key to confirm the trimmed area.

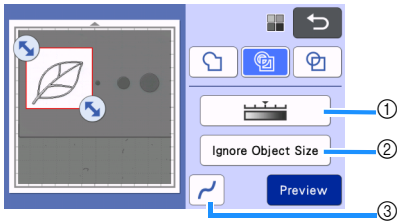

- Image Detection Level Key**
Adjust the image detection level.
- Ignore Object Size Key**
Small unnecessary patterns (dotted lines, etc.) can be excluded from cutting data. For details, see “Specifying “Ignore Object Size”” on page 81.
- Smoothing Setting Key**
Specify the level of smoothing applied to the image outline. For details, see “Adjusting Image Detection Levels” on page 81.

Color recognition mode

1 In the image trim screen, use the touch pen to drag  to trim the image to the size to be imported.

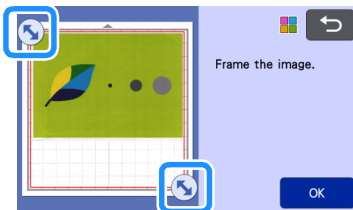

Memo

- Trimming the image to the desired size can reduce the amount of time required to convert it to cutting data.

2 Touch the “OK” key to confirm the trimmed area.

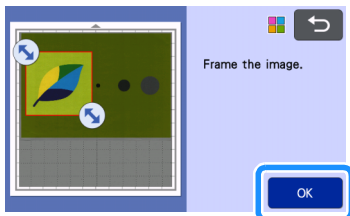

3 Select the detection standard in the image editing screen.

The image shape is detected and cutting lines are created based on one of two standards. For this



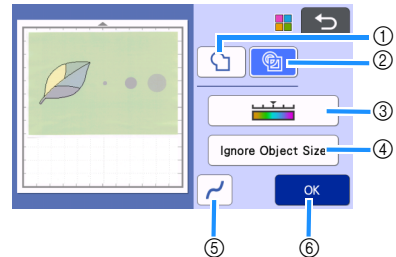

example, touch  to create cutting lines using region detection.

For details on the detection standards, see step **1** in “Grayscale recognition mode”.



- Outline Detection Key**
- Region Detection Key**

Difference in cutting lines depending on detection standard

	① Outline detection	② Region detection
Original		
Cutting lines		
Finished project after cutting		

3 **Image Detection Level Key**

If the cutting lines were not correctly detected, change the number of colors to be detected. If a color that appears as a single color is detected as separate colors, reduce the number of colors. If adjacent colors with a similar brightness are detected as a single color, increase the number of colors.

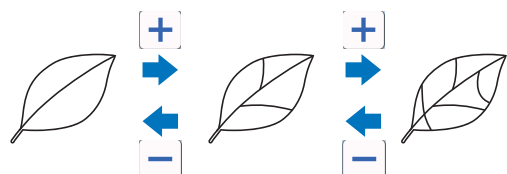

④ **Ignore Object Size Key**

Small unnecessary patterns (dotted lines, etc.) can be excluded from cutting data. For details, see “Specifying “Ignore Object Size”” on page 81.

⑤ **Smoothing Setting Key**

Specify the level of smoothing applied to the image outline. For details, see “Specifying Smoothing” on page 82.

⑥ **OK Key**

Touch the “OK” key to apply the settings. When the number of colors is changed, the “OK” key changes to the “Preview” key. After changing the number of colors, touch the “Preview” key to check the results.

 **Memo**

- When making a stamp, for example, the image may not be converted to cutting data if it contains a gradation or areas that are only partially filled with a color.

■ Saving Data

① **Select the destination where the data will be saved.**

Select the desired location. For this example, select the machine.

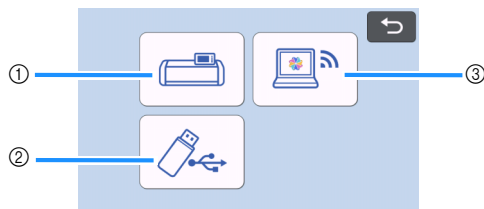

① Save to the machine's memory.

② Save to the USB flash drive.

③ Transfer to CanvasWorkspace.

▶ Touching a key starts saving the data. When the data has been saved, the following message appears.

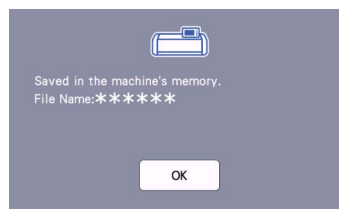

② **Touch the “OK” key to finish saving the data.**

③ **Press  in the operation panel to feed out the mat, and then peel off the original from the mat.**

Retrieve Cutting Data

Saved cutting data can be retrieved for cutting.

1 Attach the material for cutting to the mat, and then load the mat.

- For details on attaching the material, see “Attaching the material to the mat” on page 16.
- For details on loading the mat, see “Loading the Mat” on page 26.

2 Retrieve the saved cutting data.

- For details on retrieve data, follow the procedure under “Retrieve Data” on page 54.

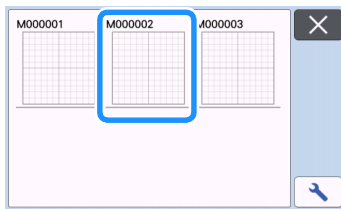

- ▶ A preview of the pattern layout appears.

3 Edit the cutting data as necessary, and then cut or draw.

For details on finishing cutting, follow the procedures under “Loading the Mat” on page 26 and “Cutting” on page 26.

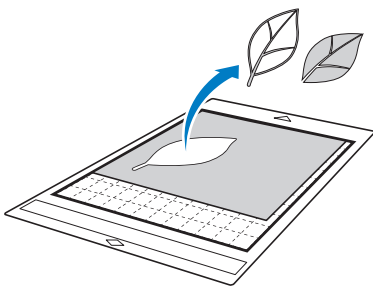
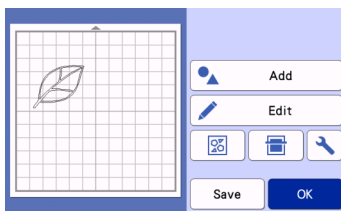

Memo

- Small spots and unwanted lines created during scanning can be deleted after a scanned image is converted to cutting data.
- ▶ After recalling the cutting data into the mat layout screen, use the editing functions for selecting the spots to delete.
For details on the function, see “Specifying the Selection Area” on page 39.

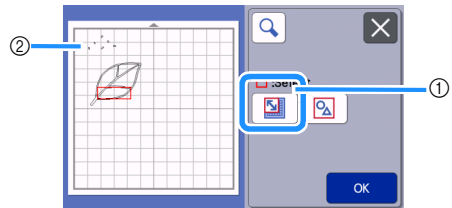

- ① Touch for selecting multiple patterns in the specified area.
- ② Unwanted spots and lines
- ▶ Specify the area of the unwanted spots, and then touch the “OK” key.

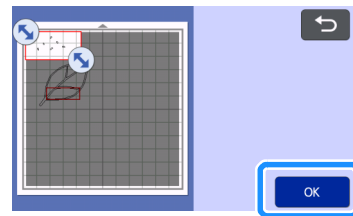

- ▶ Touch  to delete all of the selected spots.

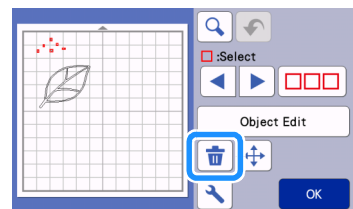

Adjusting Image Detection Levels

The output levels of the scanned image data can be adjusted.

Available in the following screen

Image editing screen	→Tutorial 4; Step ① (page 77) in “Grayscale recognition mode” or Step ③ (page 78) in “Color recognition mode”
----------------------	---

■ Specifying “Ignore Object Size”

Small unnecessary patterns (dotted lines, etc.) can be excluded from cutting data. In the following example, we will scan three images of different sizes (4 mm, 40 mm and 100 mm) and use the grayscale recognition mode of the “Scan to Cut Data” mode.

- 1 Select one of the detection options, and then touch “Ignore Object Size” to display the setting screen.

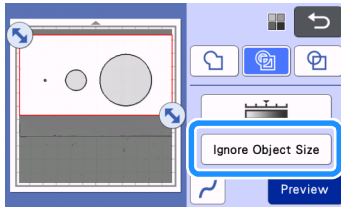

- 2 Specify an object size smaller than which is not to be converted to cutting lines.

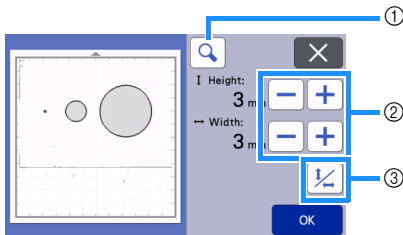

- ① Magnifying
- ② Size Adjustment Keys
- ③ Locking/Unlocking the Aspect Ratio

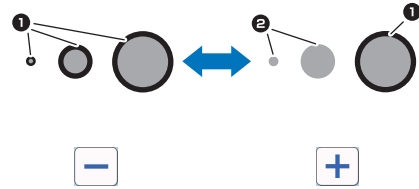

- ① Cutting line created
 - ② No cutting line created
- ▶ Touch the “OK” key to apply the settings. Touch  to return to the previous screen without applying the settings.



■ Setting Image Detection Level (Grayscale recognition mode only)

Convert an image with a gradation or shading to a two-tone (black and white) image, and then create cutting lines for that image. The image detection level (threshold) can be specified.

In the following example, we will scan three images of different tones (light, medium, dark).

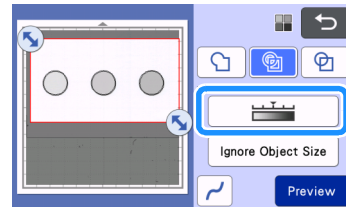
- 1 Touch  in the function selection screen to display the setting screen.



- 2 Specify the threshold for converting an image to a two-tone image using  and .

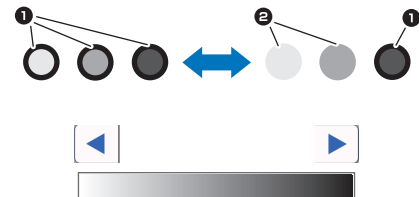
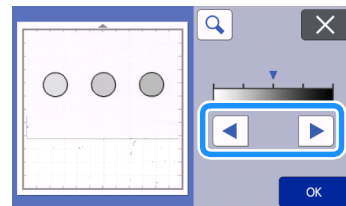

- ① Cutting line created
 - ② No cutting line created
- ▶ Touch the “OK” key to apply the settings. Touch  to return to the previous screen without applying the settings.

■ Specifying Smoothing

Curves and corners in the image can be smoothed out.

- 1 Touch  in the function selection screen to display the smoothing setting screen.



- 2 Touch  or  to specify the setting.

- Four settings are available: OFF, Low, Middle and High. Setting to "Low" is suitable for smoothing the corner and straight line.

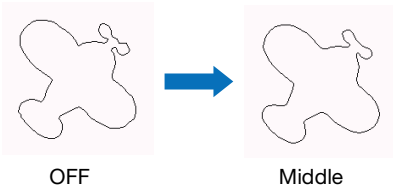
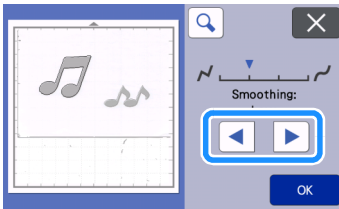

SCANNING IMAGES (Scan to USB)

A pattern printed on paper or fabric, an image, a pattern template or an original hand-drawn illustration can be scanned and saved as image data on a USB flash drive.

This is useful for saving the data of an original image as backup before cutting.

Notes on Scanning

■ Scanning Specifications

- Scanning format: Color
- Saved file format: jpg

■ Material That Can be Scanned

Thickness	Max. 3 mm
Type	Paper/Fabric
Mat	Mat suitable for the material (See "Reference Table of Mat and Material Combinations" on page 14.)

Memo

- Depending on the machine model, the sizes of mats that can be used will differ. Check the "Maximum Scanning Area" under "Machine Information" of the settings screen.
- Use the optional scanning mat to secure the paper or fabric to be scanned. The mat can be used without attaching the paper or fabric to the mat.

Tutorial 5 - Scanning to USB

In this tutorial, we will save an illustration drawn on paper as JPEG data to a USB flash drive.

■ Scan Settings

- 1 Insert the USB flash drive into the USB port (for a USB flash drive) on this machine.

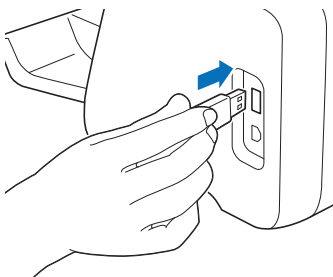

- 2 Touch the "Scan" key in the home screen to select the scanning mode.

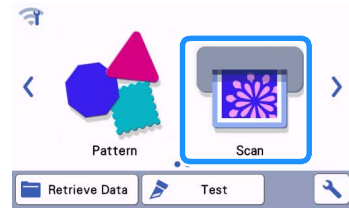

- 3 Select "Scan to USB" in the scanning mode selection screen.

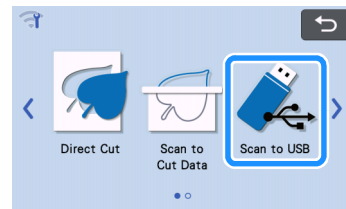

▶ A message appears.

- 4 Touch  to display the scanning settings screen.

Specify the size of the area to be scanned and the scanning resolution.

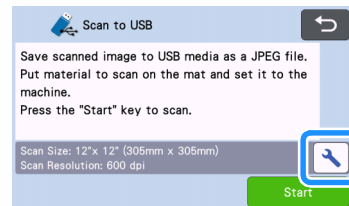

- 5 Touch the "Scan Size" button to display the scanning size settings screen.

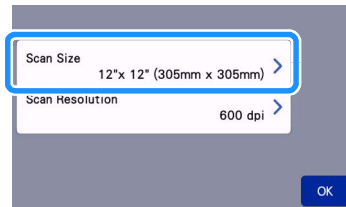

6 Select the size of the scanning area.

From the list, touch the key for the size of the original to be scanned. For this example, select the A4 size.

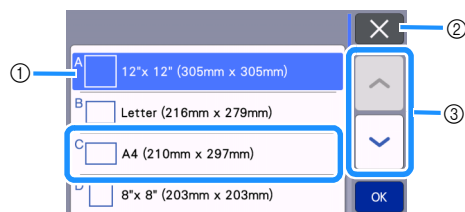

- ① Size selection keys
- ② Touch to cancel the setting and return to the previous screen.
- ③ Touch to scroll through the list.
 - ▶ After the selected key is highlighted, touch the "OK" key to finish specifying settings.

- Select "Custom", and then touch the "OK" key to specify the desired scanning area. For details, see "Selecting the Area to be Saved" on page 85.

7 Touch the "Scan Resolution" button to display the scanning resolution settings screen.

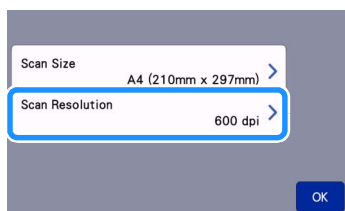

8 Select the scanning resolution.

From the list, touch the key for the scanning resolution. For this example, select 400 dpi.

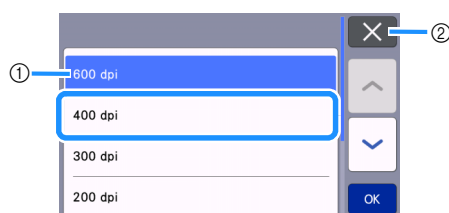

- ① Resolution selection keys
- ② Touch to cancel the setting and return to the previous screen.
 - ▶ After the selected key is highlighted, touch the "OK" key to finish specifying settings.

9 Check the settings, and then touch the "OK" key.

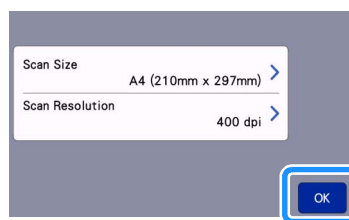

- ▶ A message appears.

Scanning and Saving

1 Attach the original that will be scanned to the mat.

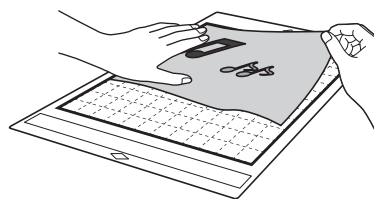

Note

- Place the original to be scanned so that it is in the landscape orientation.

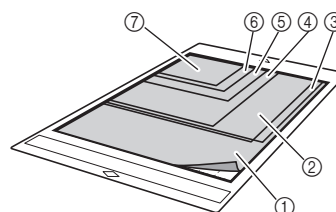

- ① 12" x 12" (305 mm x 305 mm)
- ② Letter (216 mm x 279 mm)
- ③ A4 (210 mm x 297 mm)
- ④ 8" x 8" (203 mm x 203 mm)
- ⑤ 5" x 7" (127 mm x 178 mm)
- ⑥ 4" x 6" (102 mm x 152 mm)
- ⑦ 3.5" x 5" (89 mm x 127 mm)

2 Load the mat into the feed slot.

For details on loading the mat, see "Loading the Mat" on page 26.

3 Touch the "Start" key to start scanning.

- When the scanner lever is raised, a confirmation message appears. For details, see step 7 in "Scanning" of "Tutorial 3 - Scanning and Cutting" on page 69.
 - ▶ The data is saved at the same time that the original is being scanned.
 - ▶ When scanning and saving is finished, the completion message appears.

- 4 Touch the "OK" key to exit "Scan to USB" mode.



- 5 Press  in the operation panel to feed out the mat.
- 6 Remove the USB flash drive from the USB port (for a USB flash drive) on this machine.
- 7 From a computer, check the saved image data.

Selecting the Area to be Saved

When saving a scanned image to a USB flash drive, the desired scanning area can be specified.

- 1 Follow steps 1 through 5 in "Scan Settings" of "Tutorial 5 - Scanning to USB" on page 83.
- 2 Select "Custom", and then touch the "OK" key.
- 3 Using the touch pen (stylus), drag  to select the scanning area, and then touch the "OK" key.

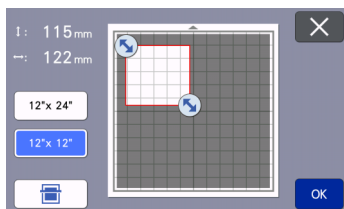

- The scanning area (white area) can also be dragged to move it.

Memo

- Load the mat with the original to be scanned attached, and then touch  to display the mat in the screen. The scanning area can be selected while viewing the displayed image.

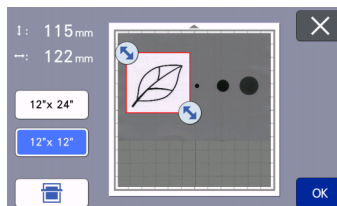

- On models compatible with 24-inch scanning, the mat size key () appears. (Touch a mat size key (or) to specify a mat size of 12" × 12" (305 mm × 305 mm) or 12" × 24" (305 mm × 610 mm).)

- 4 Continue from step 7 in "Scan Settings" of "Tutorial 5 - Scanning to USB".

Transferring an Image to CanvasWorkspace

An image scanned with the machine can be sent to CanvasWorkspace. This is useful for saving data or editing the image in CanvasWorkspace.

- 1 Select "Transfer to CanvasWorkspace" in the scanning mode selection screen.

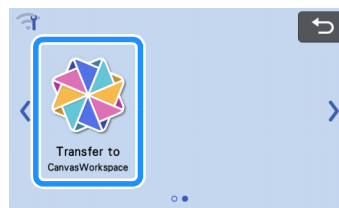

- 2 Touch  to display the scanning settings screen.

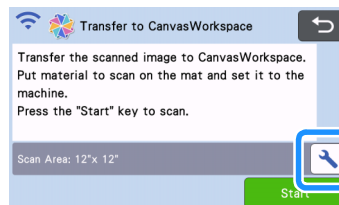

- 3** Touch the “Scan Area” button to display the scanning area settings screen.

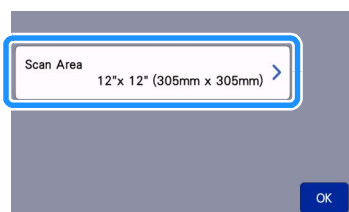

- 4** Select the size of the scanning area.

- ▶ After the selected key is highlighted, touch the “OK” key to finish specifying settings.

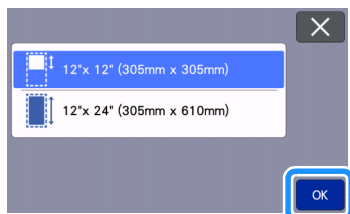

- 5** Attach the material to be scanned onto the mat.

- 6** While holding the mat level, lightly insert it into the feed slot, and then press  in the operation panel.

- For details, see “Loading the Mat” on page 26.

- 7** Touch the “Start” key to start scanning.

- When the scanner lever is raised, a confirmation message appears.
For details, see step **7** in “Scanning” of “Tutorial 3 - Scanning and Cutting” on page 69.
- ▶ For details on checking data saved in CanvasWorkspace, refer to the Help for CanvasWorkspace.

CONSUMABLES

Replacement Criteria

For the safe operation of this machine, replace the following consumables according to the replacement criteria. To purchase parts, contact the retailer who sold you this machine or the nearest authorized service center. For details on the optional accessories, see "OPTIONAL ACCESSORIES" on page 105.

Mat

- When the mat's adhesive strength decreases
- When there are many cutting traces in the mat
- When there is a deep cut from cutting in the mat

Cutting blade

- When the cuts in the material become rough, reducing the quality of the finished product
- When the cutting edge becomes blunt
- When the blade is chipped (If it cannot cut even though the blade extension or cutting pressure is set higher than necessary, the blade may be chipped.)

High tack adhesive fabric support sheet

- When the sheet's adhesive strength decreases
- When fabric attached becomes twisted while being cut

Scanning mat

- When the mat and cover sheet become dirty, reducing the quality of the scan image

Erasable pen

- When the ink is dry and not marking the fabric properly
- When the ink is used completely

Color pen

- When the ink is dry and not marking the paper or material properly
- When the ink is used completely

Replacing the Blade

■ Removing

- 1 Twist off the holder cap to remove it.

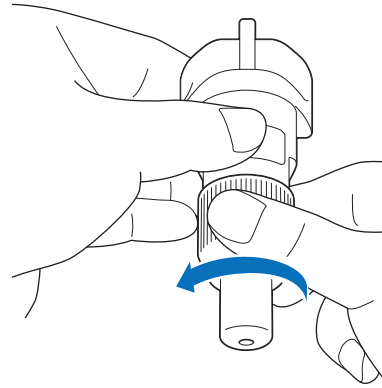

- 2 Stick the blade straight into the rubber area on the back of the included spatula.

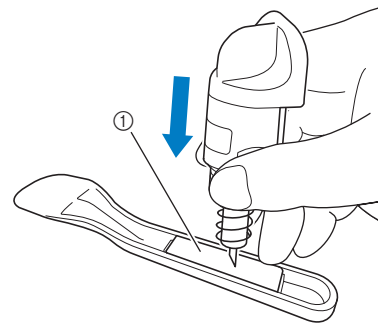

- ① Rubber area

- 3** Pull up the holder to leave the blade in the rubber area.

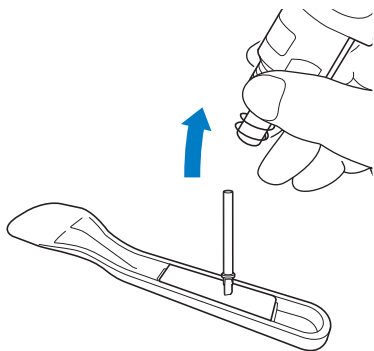

■ Installing

- 1** Grasp the shaft of the new blade, and then insert it into the blade slot in the end of the holder.

The blade shaft is held in place by a magnet in the holder. Slowly insert the blade shaft, and then slowly release it after the shaft snaps into place against the magnet.

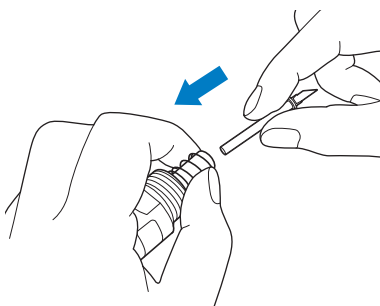

- 2** Twist on the holder cap to attach it to the holder.

Fully tighten the cap until it can no longer be turned.

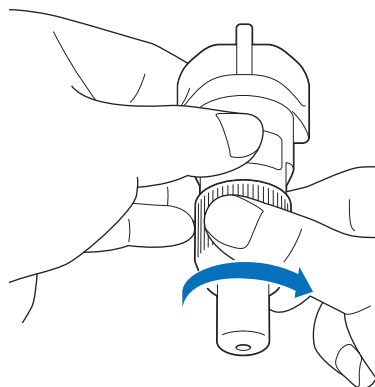

⚠ WARNING

- This is not a toy and is not intended to be used by children. In order to prevent choking hazards, do not allow infants/children to put the protective cap in their mouths.

⚠ CAUTION

- After removing the blade holder from the machine, be sure to attach the protective cap.
- Do not press the tip of the holder with your hand or fingers because the tip of the blade will extend and may result in injuries.
- Please remove protective cap from blade holder before placing it into the machine carriage.
- This is not a toy and is not intended to be used by children. In order to prevent injury, do not allow infants/children to touch the blade.

Cleaning

■ Cleaning the Mat

Cuttings and cut edges of patterns attached to the mat may reduce the mat's adhesive strength and prevent correct operation. Periodically clean the mat. Using the included spatula, lightly scrape off any cuttings attached to the mat. Strongly rubbing the adhesive side of the mat may damage it.

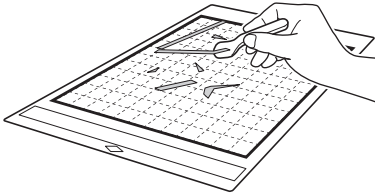

Use tweezers (available either as optional accessories or commercially) to remove any fabric threads attached to the mat.

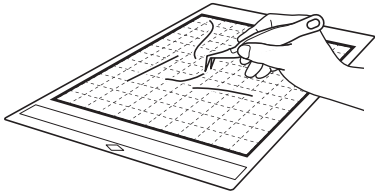

Clean the dotted marks on the mat and their surrounding area with a dry cloth.

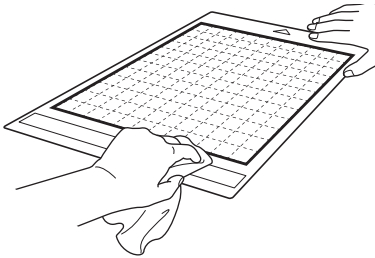

Note

- Do not use alcohol or water to clean the mat.
- When the mat is not being used, clean it, and then store it with the protective sheet affixed. If the protective sheet is not affixed, the mat's adhesive strength will decrease. At that time, do not affix the protective sheet while the mat is damp. Otherwise, the mat's adhesive strength will decrease.
- Do not fold or bend the mat to store it.
- Store the mat at room temperature and in a location not exposed to high temperatures, high humidity or direct sunlight.
- If the mat no longer has any adhesive strength, replace it with a new one. For details on optional mats, see "OPTIONAL ACCESSORIES" on page 105.

■ Cleaning the Holder

If material cuttings, lint or dust accumulate in the holder, it may not operate correctly. Clean the holder after every use.

- 1 Twist off the holder cap to remove it.

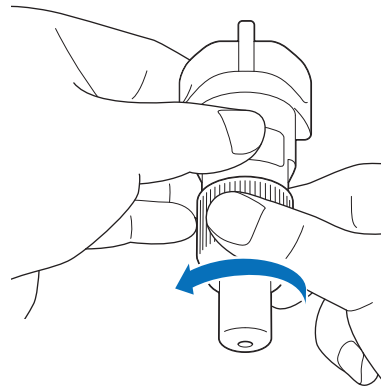

- 2 Using a commercially available brush, clean off cuttings, lint and dust.

Specifically clean off lint and dust around the blade. If lint and dust accumulate between the blade and holder, the blade may no longer rotate or the cutting quality may become poor. In addition, clean out any lint and dust that has accumulated in the cap.

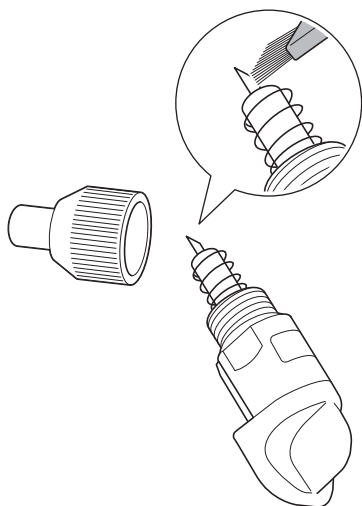

- 3 Attach the holder cap to the holder.

For details on attaching the holder cap, see “Installing” on page 88.

■ Cleaning Inside the Machine

If there are vertical lines or blank areas in the scanned image, lint or dust may have accumulated in the machine. The lint may also attach to the surface of the feed rollers, preventing a mat to be loaded or unloaded correctly. Use a soft brush to clean it.

- 1 Turn off the machine, unplug the power cord from the electrical outlet, and then disconnect the AC power cord from the AC power jack on the back of the machine.

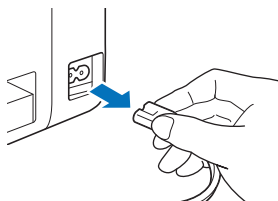

- 2 Open the front tray cover.

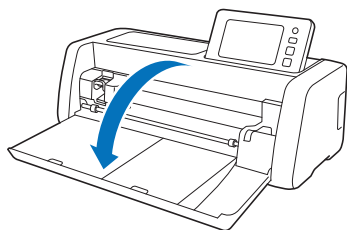

- 3 Remove the holder from the carriage.

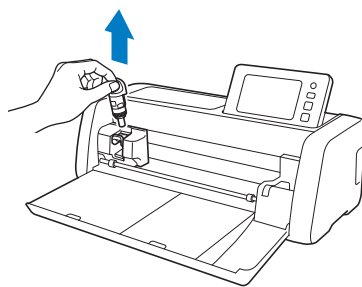

- 4 Use a commercially available brush to clean around the feed slot and the carriage.

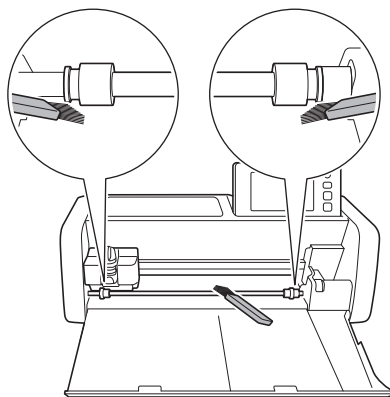

Cleaning the Scanner Glass

If there are unwanted vertical lines in the scanned image or if scanning cannot be done cleanly, the scanning area of the scanner may have become dirty. Clean the scanner glass inside the machine.

- 1 Turn off the machine, unplug the power cord from the electrical outlet, and then disconnect the AC power cord from the AC power jack on the back of the machine.

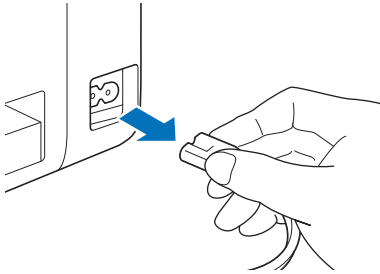

- 2 Store away the operation panel.

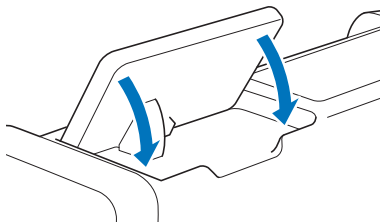

- 3 Turn the machine upside down, and then pull out the rear tray.

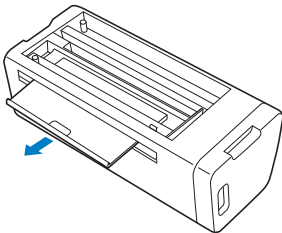

- 4 Pull the rear tray release lever (at the bottom of the machine), and then remove the cover.

Pull out the rear tray to remove it together with the cover.

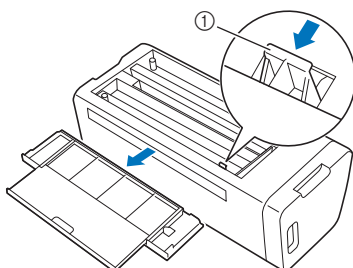

① Rear tray release lever

- 5 Dampen a soft lint-free cloth with water and firmly wring it out, and then wipe the scanner glass inside the machine.

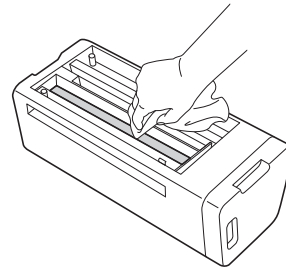

- 6 Attach the cover to the machine.
 - Push in the cover until it snaps into place.

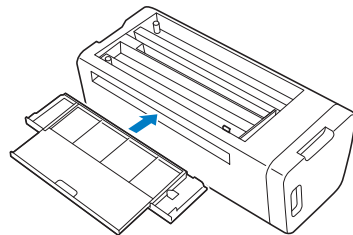

- 7 Push in the rear tray.

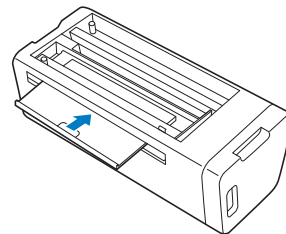

- 8 After cleaning, perform a test scan.

Adjusting the Screen

If the screen does not respond correctly when you touch a key (the machine does not perform the operation or performs a different operation), follow the steps below to make the proper adjustments.

- 1 **Holding your finger on the LCD screen, turn the main power to off and back to on. Keep your finger on the LCD screen, until Brother logo disappears.**

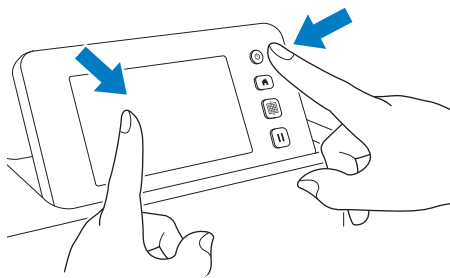

► The touch panel adjustment screen is displayed.

- 2 **Using the included touch pen (stylus), lightly touch the center of each +, in order from 1 to 5. If an error occur when touching +, start again from number 1.**

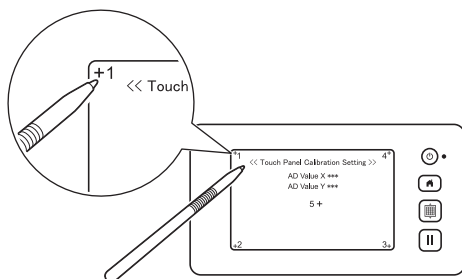

► After completing the touch panel adjustment, the message "SUCCESS" appears on the screen.

- 3 **Turn the main power to off, then turn it back to on.**

Note

- If you finish the screen adjustment and the screen still does not respond correctly, or if you cannot do the adjustment, contact the retailer who sold you this machine or the nearest authorized service center.

Adjusting the Scanning/Cutting Position

In "Direct Cut" mode, the cutting position can be automatically adjusted if it has shifted. For details on the "Direct Cut" mode, see "SCANNING FOR CUTTING (Direct Cut)" on page 69.

Materials

Paper	Thick paper Color: White Size: A4 size (210 mm × 297 mm) or Letter size (216 mm × 279 mm) Thickness: 0.2 to 0.3 mm (recommended)
Mat	Mat suitable for the material (See page 14.)
Cutting blade	Auto Blade Holder (black)

Memo

- Be sure to first test attach it to a mat suitable for the paper.

- 1 **Insert the holder into the carriage.**
 - For details, follow the procedures under "Installing and Uninstalling the Holder" on page 24.
- 2 **Attach the paper to the mat.**
 - Align the upper-left corner of the paper with the upper-left corner of the mat.
 - For details on attaching the paper, follow the procedure under "Attaching the Material (Paper)" on page 16.

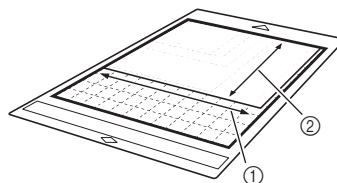

- ① Long side
- ② Short side

- 3 Touch the “Scanning/Cutting Position Adjustment” button in the settings screen.

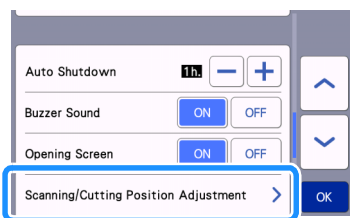

- The following message appears.



- Touch the “OK” key.

- 4 Press  to feed in the mat.

- For details, see “Loading the Mat” on page 26.

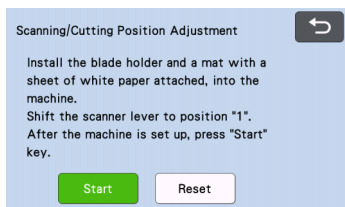

- 5 After making sure that the scanner lever (on the left side of the machine) is lowered to “1”, touch the “Start” key to start cutting.

See “Cutting” on page 26.

- Position adjustment cuts are cut, and then the cuts are scanned.



- Using the intersecting cuts on the left and right sides, the scanning position is automatically adjusted.

- 6 The adjustment results screen appears.

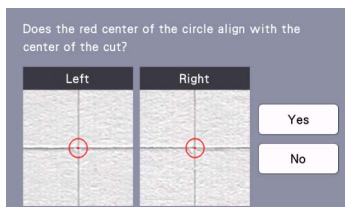

- If the center of the cut aligns with the center of the red circle, the position is properly adjusted. Touch the “Yes” key, and then continue with step 7.
- If the center of the cut does not align with the center of the red circle, the position is improperly adjusted. Touch the “No” key, replace the paper attached to the mat, and then repeat steps 4 through 6 to readjust the position.

- 7 When the following message appears, touch the “OK” key.



- The adjustment is finished.



Note

- To return the settings to their defaults, touch the “Reset” key in the screen shown below.

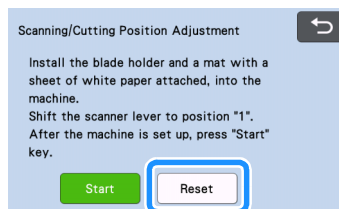

- 8 Use “Direct Cut” mode to check the adjustment results.



- For details on the “Direct Cut” mode, see “SCANNING FOR CUTTING (Direct Cut)” on page 69.

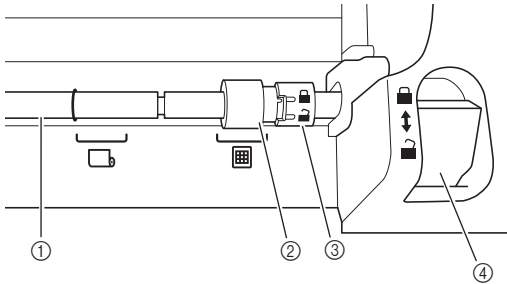

Adjusting the Position of the Feed Roller

For normal operations (when the optional roll feeder is not used), it is not necessary to adjust the position of the feed roller. If the feed roller is inadvertently moved, follow the procedure below to return it to its original position.

For details on using the roll feeder, refer to the manual included with it.



- ① Shaft
- ② Feed roller
: Move the feed roller to this position for normal operations.
: Move the feed roller to this position when the roll feeder is being used.
- ③ Feed roller lock dial
Rotates forward/backward to lock/release the feed roller.
- ④ Feeder release lever
Locks/releases the shaft.

- 1** Pull the feeder release lever toward you to release the shaft.
- 2** Rotate the feed roller lock dial toward the back to unlock the feed roller, and then move the feed roller to the  mark.
- 3** Rotate the feed roller lock dial toward you to lock the feed roller, and then push the feeder release lever to the  position.



Note

- Be careful not to pinch your fingers while operating the feeder release lever.
-

TROUBLESHOOTING

Please pay attention to all applicable safety warnings when referring to the sections cited below. If the machine stops operating correctly, check the following possible problems before requesting service. You can solve most problems by yourself. If you need additional help, the Brother Solutions Center offers the latest FAQs and troubleshooting tips. Visit us at “ <http://s.brother/cpoac/> “. If the problem persists, contact the retailer who sold you this machine or the nearest authorized service center. For wireless network troubleshooting, refer to “Wireless Network Setup Guide”.

Power Supply

Symptom	Possible Causes (or Results)	Solutions	Reference
The machine cannot be turned on.	The AC power cord is not correctly connected to the machine.	Check that the power cord is connected to the electrical outlet.	page 8

Mat

Symptom	Possible Causes (or Results)	Solutions	Reference
The mat cannot be inserted.	When the mat was inserted, it was not placed under the feed rollers.	Insert the mat so that it is placed under the feed rollers on the left and right sides of the feed slot.	page 26
	The mat was not loaded using the “Feed” button.	Lightly insert the mat into the feed slot, and then press the “Feed” button.	page 26
	The feed roller is not positioned correctly.	Adjust the position of the feed roller.	page 94
	The shaft is released.	Lock the shaft.	page 94
The mat cannot be recognized.	The dotted marks on the part of the mat that is inserted are dirty.	Clean the dotted marks on the mat and their surrounding area.	page 89
	The dotted marks on the part of the mat that is inserted are hidden by material that was attached.	Attach the material while keeping it within the adhesive area of the mat.	page 16
	The mat was inserted so that the side with the material attached is facing down.	Insert the mat so that the side with the material attached is facing up.	page 26
	The mat was inserted in the wrong direction.	Insert the mat in the correct direction.	page 26
	The scanner glass is dirty.	Clean the scanner glass inside the machine.	page 91
	A mat designed specifically for this machine is not used.	Replace the mat with one designed specifically for this machine.	—
The mat is fed in at an angle.	The mat was inserted into the feed slot at an angle.	Press the “Feed” button to feed out the mat, and then re-insert it straight in.	page 26 page 27
	The corners of the mat are deformed (bent).	Replace the mat with a new one.	page 87
	The rear tray is not pulled out.	Pull out the rear tray.	page 7 page 9
	The feed roller is not positioned correctly.	Adjust the position of the feed roller.	page 94
The material to be cut/drawn or original to be scanned cannot be attached to the mat.	The material extends from the adhesive area of the mat.	Attach the material while keeping it within the adhesive area of the mat.	page 16
	The mat’s adhesive strength has decreased.	Replace the mat with a new one.	page 87
The mat cannot be fed out.	The material to be cut/drawn or original to be scanned is jammed in the feeding mechanism in the machine.	Press the “Feed” button while the mat is being inserted to feed it out. If the mat does not feed out, turn off the machine, and then carefully pull out the mat.	page 27

Symptom	Possible Causes (or Results)	Solutions	Reference
When the mat is inserted, the attached material peels off.	The mat is not level due to the weight of the material.	With your hands, hold the mat level when inserting it.	page 26
	The mat's adhesive strength has decreased.	Replace the mat with a new one.	page 87

Paper/Fabric Jam

Symptom	Possible Causes (or Results)	Solutions	Reference
The mat cannot be fed.	There is an obstruction around the slot at the back of the machine.	Maintain space around the slot at the back of the machine so that the mat can be fed out.	page 7
	The surface where the machine is installed is uneven.	Place the machine on a flat, even surface.	—
The mat or the material catches on a feed roller when the mat is being inserted.	The mat's adhesive strength has decreased, or the material is not secured.	Press the "Feed" button to feed out the mat, and then replace the mat with a new one.	page 27 page 87
	The material extends from the adhesive area of the mat.	Press the "Feed" button to feed out the mat, and then attach the material while keeping it within the adhesive area of the mat.	page 16 page 27
	The thickness of the material exceeds the maximum limit.	Press the "Feed" button to feed out the mat, raise the scanner lever, and then correctly insert the mat. Press the "Feed" button to feed out the mat, and then change the material to a thin one.	page 7 page 9 page 27 —
The mat or the material catches on a feed roller during cutting/drawing/scanning.	<ul style="list-style-type: none"> - The mat's adhesive strength has decreased, or the material is not secured. - The material extends from the adhesive area of the mat. - The rear tray is not pulled out. 	Press the "Pause/Stop" button to stop the operation. Follow the instructions on the screen, and press the "Feed" button to feed out the mat.	page 7 page 9 page 16 page 27 page 87
The mat is fed in at an angle and is not fed during cutting/drawing/scanning.		If the mat does not feed out, turn off the machine, remove the holder, and then manually feed out the mat. After feeding out the mat, replace it with a new one or attach the material while keeping it within the adhesive area of the mat. Pull out the rear tray, and then insert the mat.	
The material to be cut/drawn or original to be scanned peels off during cutting/drawing/scanning.			

Cutting

Symptom	Possible Causes (or Results)	Solutions	Reference
The material being cut catches on the tip of the cutting blade.	Dust or lint has accumulated in the holder.	Clean the holder.	page 89
	The blade is worn.	Replace the blade with a new one.	page 87
	The material being cut is incompatible with this machine.	Replace the material with one compatible with this machine.	page 14
The machine stopped while an operation is being performed.	For safety, the machine stops operating if the panel is touched while cutting.	Follow the instructions in the message that appears in the screen. Touch the "OK" key to move the carriage to its initial position. Load the mat and perform the operation again.	—

Symptom	Possible Causes (or Results)	Solutions	Reference
Not all of the material to be cut is cut. Some areas remain uncut.	A blade appropriate for the material being cut is not used.	Use a blade appropriate for the material being cut.	page 23
	If cutting is not possible even though the cutting pressure is set higher than necessary, the blade may be chipped.	Replace the blade with a new one.	page 87
	The mat's adhesive strength has decreased, or the material is not secured.	Replace the mat with a new one.	page 87
	The blade is worn.	Replace the blade with a new one.	page 87
	The material is incompatible with this machine.	Replace the material with one compatible with this machine.	page 14
	The cutting pressure ("Cut Pressure") is incorrect.	Adjust the setting for "Cut Pressure" in the settings screen.	page 10 page 27
	Dust or lint has accumulated in the holder.	Clean the holder.	page 89
	The spacing between arranged patterns is too small.	Rearrange the patterns to slightly separate them. Set the number to "3" or higher in the "Pattern Interval" setting, and then rearrange the patterns or perform the auto layout function.	page 10 page 49
	The material extends from the adhesive area of the mat.	Attach the material while keeping it within the adhesive area of the mat.	page 16
	Fabric was cut without using a sheet for fabric cutting.	Attach a high tack adhesive fabric support sheet to a mat or affix an iron-on fabric appliqué contact sheet to a fabric before cutting it.	page 17 page 20
	A fabric is not firmly attached to a mat that has a high tack adhesive fabric support sheet on its adhesive side.	Firmly attach the fabric to the mat pressing the handle of the included spatula across the surface of the fabric.	page 20
An iron-on fabric appliqué contact sheet is not firmly attached to a fabric.	Iron the entire contact sheet to affix it firmly to the wrong side of the fabric.	page 17	
There are deep cuts completely through the mat.	The cutting pressure ("Cut Pressure") is incorrect.	Adjust the setting for "Cut Pressure" in the settings screen.	page 10 page 27
The material to be cut is not cleanly cut.	After using a mat with deep cut marks which completely went through the mat, the machine's surface where the blade points down (①) has cut marks. 	Contact the retailer who sold you this machine or the nearest authorized service center.	—

Drawing

Symptom	Possible Causes (or Results)	Solutions	Reference
The drawn line is thicker (thinner) than intended.	The drawing speed ("Draw Speed") or drawing pressure ("Draw Pressure") is incorrect.	Adjust the settings for "Draw Speed" and "Draw Pressure" in the settings screen. To draw thicker lines, increase the drawing pressure. To draw thinner lines, decrease the drawing pressure. To draw thicker lines, reduce the drawing speed. To draw thinner lines, increase the drawing speed. After adjusting the settings, perform a test/trial drawing operation.	page 10 page 62
The machine stopped while an operation is being performed.	For safety, the machine stops operating if the panel is touched while drawing.	Follow the instructions in the message that appears in the screen. Touch the "OK" key to move the carriage to its initial position. Load the mat and perform the operation again.	—

Scanning

Symptom	Possible Causes (or Results)	Solutions	Reference
Unwanted images are scanned.	The scanning area is incorrectly specified.	In "Scan to USB" mode, specify the paper size with the "Scan Size" setting.	page 83
		In "Direct Cut" or "Scan to Cut Data" mode, trim the image in the editing screen after scanning.	page 71 page 77
Scanning cannot be done cleanly (there are lines in the scanned image).	The scanner glass is dirty.	Clean the scanner glass inside the machine.	page 91
	The original to be scanned is dirty or scratched.	In "Direct Cut" or "Scan to Cut Data" mode, remove thin lines or dirt in the image editing screen.	page 81
The lines printed on the mat are scanned.	The original is transparent so the lines printed on the mat are being scanned.	In "Direct Cut" or "Scan to Cut Data" mode, remove the lines in the image editing screen.	page 81
The scanned image is red.	When the optional scanning mat is used, scanning is performed without peeling off the blue tape.	Peel off the blue tape from the optional scanning mat before scanning.	—
The scan image is out of focus.	The scanner lever is not correctly positioned for the thickness of the material	Set the scanner lever position to "1".	page 9

ERROR MESSAGES

The following table lists some of the messages that may appear while the machine is operating as well as their corresponding solutions.

Perform the necessary operation according to the instructions in the message or the solution described here.

If the problem persists, contact the retailer who sold you this machine or the nearest authorized service center.

Error Messages	Causes / Solutions
A malfunction occurred. Turn the machine off, then on again.	Turn the machine off, then on again.
Built-in memory is corrupted. Initialize the memory.	The data on the machine's memory is corrupted. Restart the machine.
Cannot operate when there are too many patterns.	<p>The message appears under the following conditions:</p> <ul style="list-style-type: none"> - In "Direct Cut" mode, more than the maximum number of patterns have been detected for the cutting pattern. - In "Scan to Cut Data" mode, more than the maximum number of patterns are being saved as cutting data. <p>Reduce the number of patterns being used.</p> <p>* Depending on the machine model, the maximum number of patterns will differ. Check the "Maximum Pattern Number" under "Machine Information" of the settings screen.</p> <ul style="list-style-type: none"> - There are too many cutting lines to be created after large number of small patterns are scanned. - There are too many light tone patterns to be converted to two-tone (black and white) patterns while the image detection level is being adjusted. <p>Scan images again after reducing the number of patterns arranged in the original.</p>
Cannot operate when there is no pattern.	<p>There is no scanned image or lines for scanning. Recheck the image to be scanned, and adjust the scanning area, image detection level and "Ignore Object Size" settings.</p> <p>In addition, change the image drawn on the original to one more easily scanned.</p>
Cannot read the data. Get the PIN code again and register to the machine.	<ul style="list-style-type: none"> - This message appears when you try to transfer data with a machine different than the one registered with CanvasWorkspace. - The registration of your machine has been canceled from CanvasWorkspace. Register the machine to be used again.
Cannot save the data. Get the PIN code again and register to the machine.	
Includes a special pattern that cannot be saved to external memory. Save the pattern in the machine's memory.	Depending on the pattern, it may not be possible to save it to external memory (USB flash drive or CanvasWorkspace).
Initialization of the blade position failed. Turn the machine off.	Turn the machine off, then on again.
Initialization of the head failed. Turn the machine off.	
No more patterns can be added to this combination.	<p>More than the maximum number of patterns are being combined. Reduce the number of patterns.</p> <p>* Depending on the machine model, the maximum number of patterns will differ. Check the "Maximum Pattern Number" under "Machine Information" of the settings screen.</p>
No pattern in the effective area.	<p>There is no pattern(s) to be cut out or drawn within the cutting area.</p> <p>To cut out or draw a pattern outside of the area, increase the setting for "Cut Area", or move the pattern(s) into the area specified with "Cut Area" (page 10).</p>
Not enough available memory to save the data.	Delete a file from the machine's memory or USB flash drive.

Error Messages	Causes / Solutions
<p>Not enough space on the mat. Check pattern size, space on the mat, Cut Area (setting) or Pattern Interval (setting).</p>	<p>Perform one of the following to arrange the patterns.</p> <ul style="list-style-type: none"> - Delete a pattern already arranged in the mat layout screen. - Resize a pattern in the arrangement. - Enlarge the setting for "Cut Area" (page 10). - Reduce the spacing between arranged patterns using the "Pattern Interval" setting.
<p>Not enough space on the mat. Max: 10 (example: calculated number)</p>	<p>Since there are too many patterns, they cannot be arranged. Reduce the number of patterns to the maximum shown on the screen.</p>
<p>OK to retrieve and resume previous memory?</p>	<p>To use data from the previous operation, touch the "OK" key. (page 12)</p>
<p>Patterns cannot be unified. Invalid pair was selected.</p>	<p>The message appears when you are unifying patterns. Patterns with seam allowances and no seam allowances are selected as pairs. Select patterns, all of which have either seam allowances or no seam allowances.</p>
<p>Patterns cannot be welded. There are some patterns which cannot accept or no overlaps.</p>	<p>The message appears when you are welding patterns.</p> <ul style="list-style-type: none"> - The patterns do not overlap. Rearrange them so the selected patterns overlap. Unifying the pattern, instead, can be an alternative editing method depending on your project. - A pattern that has a seam allowance is selected. Deactivate the seam allowance setting and weld the patterns. - An open shape is selected as a pattern. Only closed shapes can be welded. Unifying the pattern, instead, can be an alternative editing method depending on your project.
<p>Replace the mat with 12 × 24 inch mat.</p>	<p>The 12" × 12" mat was loaded although 24-inch data was created. Load the 12" × 24" mat.</p>
<p>Scanning error occurred. Turn the machine off.</p>	<p>Turn the machine off, then on again, and then try performing the operation again.</p>
<p>Since the shape was larger than the mat, it was reduced in size when imported.</p>	<p>If the pattern in the imported SVG file is larger than the mat, the pattern will be reduced to fit the size of the mat. If necessary, in the software used to create the SVG file, edit the pattern to fit the size of the mat.</p>
<p>Some shapes could not be converted.</p>	<p>The imported SVG data contains data that cannot be converted, such as images or text. All other data was read as cutting line data.</p>
<p>The data cannot be deleted.</p>	<p>The USB flash drive being used may not be usable with this machine. If removing the USB flash drive and performing the operation again causes the message to appear again, replace the USB flash drive. For information about USB flash drive compatible with this machine, visit our website "http://s.brother/cpoac/".</p>
<p>The data cannot be read.</p>	
<p>The data cannot be saved.</p>	
<p>The data could not be imported. There are too many patterns.</p>	<p>The message appears when an SVG file contains more than the maximum number of patterns. In the software used to create the SVG file, reduce the number of patterns. * Depending on the machine model, the maximum number of patterns will differ. Check the "Maximum Pattern Number" under "Machine Information" of the settings screen.</p>
<p>The data is too complicated to be imported.</p>	<p>SVG files containing a complicated pattern cannot be imported. In the software used to create the SVG file, simplify the pattern.</p>
<p>The mat cannot be recognized. The mat will unload.</p>	<p>A mat that cannot be recognized has been inserted. If a mat designed specifically for this machine is not being used, use the specially designed mat.</p>
	<p>Clean the dotted marks at the edge of the mat and their surrounding area. If the mat is still not recognized, replace the mat with a new one.</p>

Error Messages	Causes / Solutions
There are no patterns that can be detected.	The imported SVG data contains data that cannot be converted, such as images or text.
There are some patterns which cannot add seam allowance.	The seam allowance settings cannot be specified for complex pattern shapes. Select a pattern with a simple shape. Expanding the seam allowance to 2 mm or more may help.
There are some patterns which cannot set cutting distance from the outline.	The cutting distance cannot be specified for complex pattern shapes. Select a pattern with a simple shape.
This data is too complicated and cannot be converted.	Complex patterns cannot be welded or filled. Reduce the number of patterns arranged or change the patterns to ones with simple designs.
This mat cannot be used.	The mat is one that cannot be used with the function being performed. Replace the mat. (For example, the scanning mat was loaded while trying to cut.)
Cooling Down	The machine has stopped cutting/drawing to cool down the hot part inside the machine. Leave it for a while then follow the instruction on the screen to restart. If this message appears often, contact the retailer who sold you this machine or the nearest authorized service center.

UPDATING THE SOFTWARE

The machine's software can be updated with any of the following three procedures.

- Updating Using Automatic Update Function
 - Updating from the Home Screen
 - Updating from the Settings Screen
- Updating Using a USB Flash Drive
- Updating Using the Application (CanvasWorkspace)

Automatic Update Function

The machine can be updated by retrieving update files directly from the Internet.

Memo

- Before using this function, register your machine with CanvasWorkspace, and connect the machine to the network. For details on registering, refer to "Wireless Network Setup Guide".

Updating from the Home Screen

1 Touch **i** in the home screen.

- If there is no new update file, **i** does not appear in the home screen.

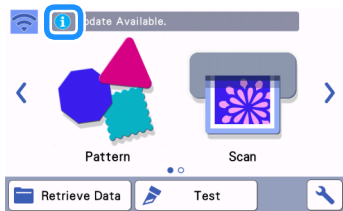

2 Touch the "Update" key to retrieve the software.



- ▶ When the update is finished, the machine automatically restarts.

Note

- Do not turn off the machine while it is being updated.

Updating from the Settings Screen

1 Touch  in the home screen to display the settings screen, and then touch the "Ver." button.

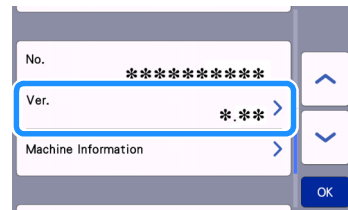

- ▶ The update method selection screen appears.

2 Touch .

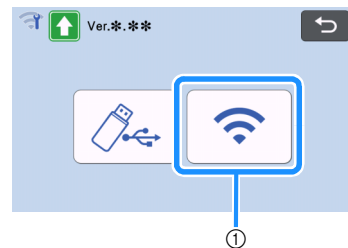

- ① Update automatically

3 Updating begins.

- Refer to step 2 in "Updating from the Home Screen".
- ▶ If there is no new update file, the following message appears.

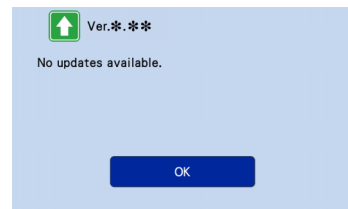

Note

- If the automatic update fails, retrieve the update file from the Brother Solutions Center (<http://s.brother/cuoad/>), and then update your machine using a USB flash drive.

Update Procedure Using USB Flash Drive

Using a USB flash drive, the machine's software can be updated. For update information, refer to details posted on the Brother Solutions Center (<http://s.brother/cuoad/>). If an update file is posted, download the file, and then update the machine according to the following procedure.

1 Insert the USB flash drive containing the update file into the USB port on this machine.

The USB flash drive must not contain any data other than the update file. Otherwise, the machine may stop operating correctly.

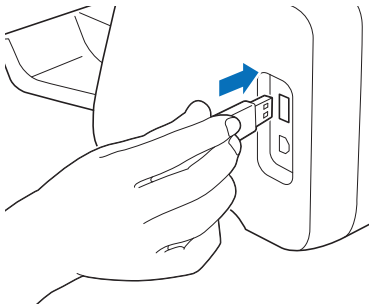

Note

- This machine is incompatible with a USB hub. Insert the USB flash drive directly into the USB port.

2 Touch in the home screen to display the settings screen, and then touch the "Ver." button.

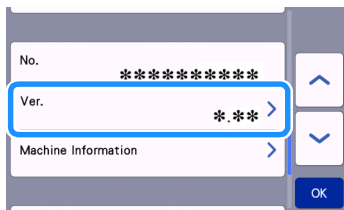

- ▶ The update method selection screen appears.

3 Touch .

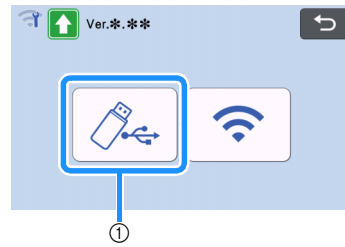

- ① Update using USB flash drive

4 Touch the "Update" key to start the update.

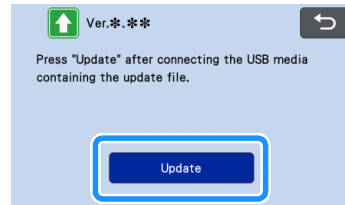

- ▶ When the update is finished, the machine automatically restarts.

5 Remove the USB flash drive from the port.



Note

- Do not remove the USB flash drive while the machine is being updated.

Update Procedure Using the Application (CanvasWorkspace)

With this function, the machine can be connected to a computer with a USB cable in order to retrieve the update file from CanvasWorkspace to update the machine. Before using this function, install CanvasWorkspace on the computer.

■ USB cable (sold separately)

- We recommend using a USB 2.0 cable (Type A/B) that is no longer than 2 meters (6 feet).

1 Insert the USB cable connectors into the corresponding USB ports on the computer and on the machine, and then turn on the machine.

2 Display the home screen on the machine.

- 3** Start up CanvasWorkspace, and then click [Check for the Latest ScanNCut DX Update...] on the [Help] menu.

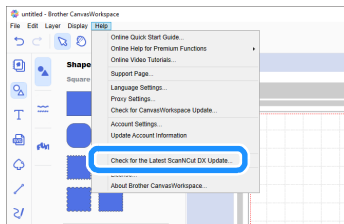

- ▶ When the following message appears, click [OK] to update the software.

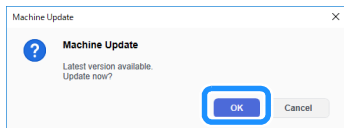

- ▶ If there is no new update file, the following message appears.

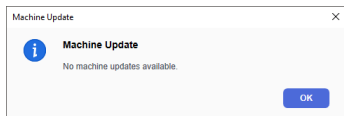

- 4** When the machine receives the update file, the following screen appears. When the update is finished, the machine automatically restarts.

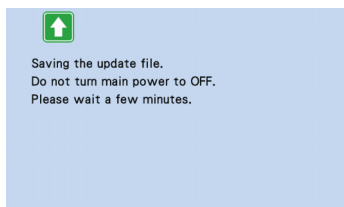

OPTIONAL ACCESSORIES

The following are available as optional accessories to be purchased separately.

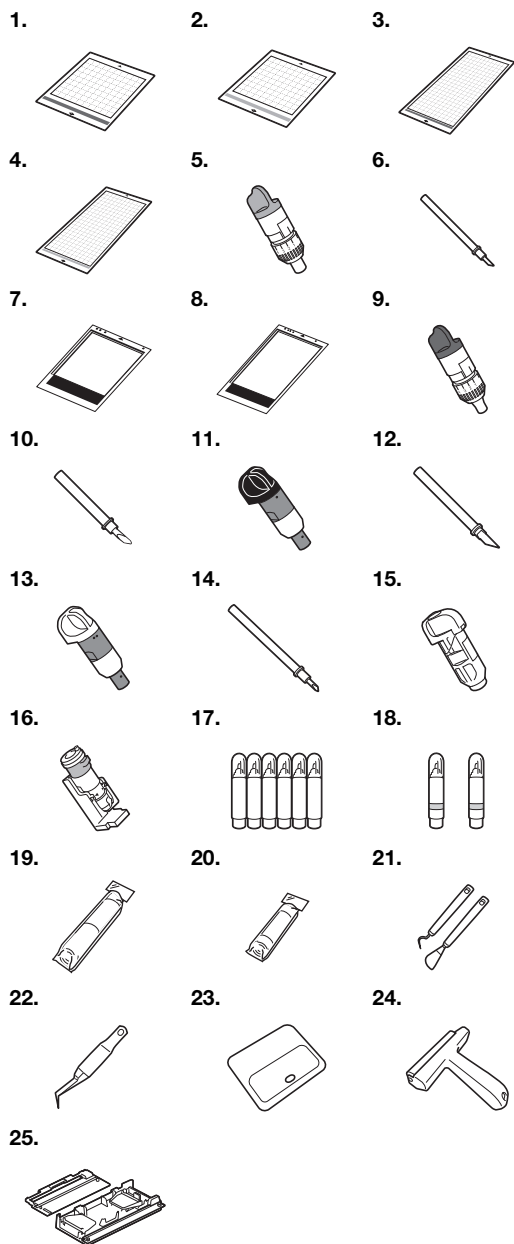

No.	Part Name	Part Code
1	Low Tack Adhesive Mat 12" × 12" (305 mm × 305 mm)	CADXMATLOW12
2	Standard Tack Adhesive Mat 12" × 12" (305 mm × 305 mm)	CADXMATSTD12
3	Low Tack Adhesive Mat 12" × 24" (305 mm × 610 mm)	CADXMATLOW24
4	Standard Tack Adhesive Mat 12" × 24" (305 mm × 610 mm)	CADXMATSTD24
5	Standard Cut Blade Holder (turquoise) (with no blade)	CAHLP1

No.	Part Name	Part Code
6	Standard Cut Blade	CABLDP1
7	Scanning Mat 12" × 12" (305 mm × 305 mm)	CADXMATS12
8	Scanning Mat 12" × 24" (305 mm × 610 mm)	CADXMATS24
9	Deep Cut Blade Holder (purple) (with no blade)	CAHLF1
10	Deep Cut Blade	CABLDF1
11	Auto Blade Holder	CADXHLD1
12	Auto Blade	CADXBLD1
13	Thin Fabric Auto Blade Holder	CADXHLDQ1
14	Thin Fabric Auto Blade	CADXBLDQ1
15	Pen Holder	CAPENHL1
16	Universal Pen Holder	CAUNIPHL1
17	Color Pen Set	CAPEN1
18	Erasable Pen Set	CAPEN2
19	Iron-on Fabric Appliqué Contact Sheet (White Backing)	CASTBL1
20	High Tack Adhesive Fabric Support Sheet	CASTBL2
21	Spatula and Hook Set	CASPHK1
22	Precision Tweezers	CATWZ1
23	3.9 inch (100 mm) Scraper	CASCP1
24	4 inch (102 mm) Brayer / Roller	CABRY1
25	Roll Feeder	CADXRF1

- * Contact the retailer who sold you this machine or the nearest authorized service center.
- * Use a mat designed specifically for this machine. The machine will not operate correctly if any other mat is used.
- * For the newest information and manuals on optional accessories compatible with this machine, refer to the Brother Solutions Center (<http://s.brother/ccoaab/>).
- * The blade extension and cutting pressure must be adjusted manually with the Standard Cut Blade Holder (turquoise) and Deep Cut Blade Holder (purple). For details on making adjustments, refer to the Brother Solutions Center (<http://s.brother/cfoae/>).

PRODUCT SPECIFICATIONS

Items	Specifications
Dimensions	Approx. 531 mm (W) × 215 mm (D) × 173 mm (H) (Approx. 20.9 inches (W) × 8.5 inches (D) × 6.8 inches (H))
Weight	Approx. 6 kg (Approx. 13.2 lb)

INDEX

- A**
 - AC power jack7
 - Advanced pattern cutting32
 - Aligning Patterns47
 - Auto blade23
 - Auto shutdown11, 12
- B**
 - Background10
 - Background scanning50
 - Basic pattern cutting29
 - Buzzer sound11
- C**
 - CanvasWorkspace5, 53, 55
 - Carriage6, 24
 - Character input functions51
 - Cleaning89
 - Cut area10, 41
 - Cut pressure10
 - Cut speed10
 - Cutting around drawings63
 - Cutting blade replacement87
 - Cutting line77
- D**
 - Direct cut69
 - Color recognition mode70
 - Grayscale recognition mode70
 - Draw pressure11, 63
 - Draw speed11, 63
 - Drawing functions62
- E**
 - Error messages99
- F**
 - Feed slot26
- G**
 - Grouping/Ungrouping Patterns44
- H**
 - High tack adhesive fabric support sheet13, 20
 - Holder lock lever6, 24
 - Holder setting24
 - Home screen9, 29
- I**
 - Image editing screen72, 77, 78, 81
 - Image trim screen71, 73, 78
 - Iron-on fabric appliqué contact sheet13, 17
- L**
 - Language10
 - Layout editing functions42
 - Layout Interval10
 - Low tack adhesive mat13
- M**
 - Main power switch8, 29
 - Mat and material combinations14
 - Mat editing screen38
 - Mat layout screen30, 41
 - Mat loading26
 - Mat unloading27
- O**
 - Opening screen8, 11
 - Operation panel7
 - Optional accessories105
 - Outline distance73
 - Outlining and framing74
- P**
 - Parts and functions6
 - Pattern category selection screen29
 - Pattern editing functions40
 - Pattern editing screen29, 40
 - “Pattern” mode4
 - Pattern piece editing screen33, 41
 - Pattern piece list screen33
 - Pattern selection screen29, 33
 - Pattern sizing screen33
 - Pattern sub-category selection screen32
 - PES58
 - PHC58
 - Picture editing81
 - Preview screen31
- R**
 - Rear tray7, 9
 - Attaching91
 - Removing91
 - Recalling54
 - Replacement criteria87
 - Required material condition (scanning)69, 83
- S**
 - Saving53
 - “Scan” mode4, 69
 - Scan to cut data75
 - Color recognition mode76
 - Grayscale recognition mode75
 - Scan to USB83
 - Scanner lever6, 9, 63, 71
 - Scanning/Cutting position calibration92
 - Seam allowance11, 43, 63
 - Selecting multiple patterns38
 - Settings screen10
 - Software update102
 - Standard tack adhesive mat13
- T**
 - Terms of Usei
 - Test/Trial Cut25
 - Thin fabric auto blade23
 - Touch screen calibration92
 - Troubleshooting95
- U**
 - Unit10
 - USB port7, 53, 103
- W**
 - Welding (merging the outlines of multiple patterns)46
 - Wireless network5, 12, 53, 55

Please visit us at <http://s.brother/cpoac/> where you can get product support and answers to frequently asked questions (FAQs).

These machines are approved for use in the country of purchase only. Local Brother companies or their dealers will only support machines purchased in their own countries.